

Union Pacific Railroad Company 2022 Standards Manual

Fiber Optic Engineering, Construction and Maintenance Standards



Photo by Gary Voogd

These standards are developed for fiber optic customer construction and associated work practices. To access this manual online visit www.up.com/fiber

Call Before You Dig: 1-800-336-9193

or online at www.up.com/cbud



BUILDING AMERICA®

Safety is Union Pacific's No.1 priority. Many UP employees have made a personal commitment to have the "Courage to Care" – which means choosing the safe course of action, offering safety suggestions to others and openly accepting feedback. As a valued customer, we hope you will also consider embracing Courage to Care.

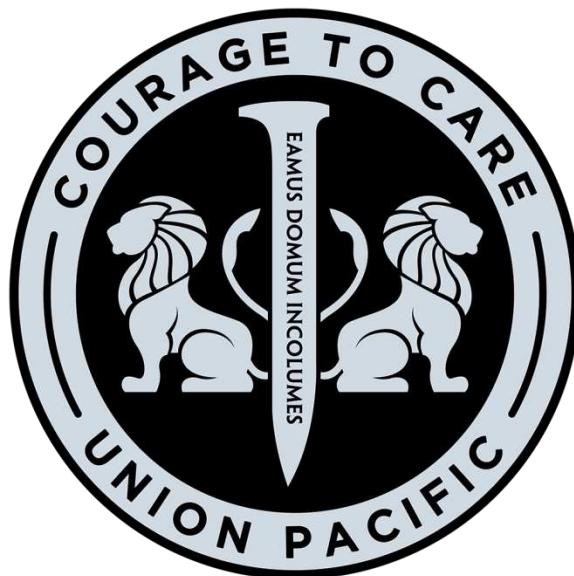

I have the courage to care. Worn with a lion's pride, it means those I work with will have my back, and I will have theirs. I pledge to shield myself and my team from harm. I will take action to keep them safe, by fixing an unsafe situation, addressing an unsafe behavior or stopping the line. In turn, I will have the courage to accept the same actions from my coworkers, who care enough to correct my path. We wear this badge out of respect for each other and those who have gone before us. On my watch, we will all go home safe to our families every day.

EXHIBIT A – CONTACTS

UNION PACIFIC RAILROAD COMPANY

Commercial Telecommunications Group
1400 Douglas Street – Mail Stop 0640
Omaha, NE 68179

ADMINISTRATION & CONSTRUCTION

ERIC ANDREWS
DIRECTOR
MAIL STOP 0640
(402) 544-8509
EJANDREWS@UP.COM

MIKE WALLMAN
SYSTEMS ENGINEER
MAIL STOP 0640
(402) 544-0577 C (402) 415-9877
MWALLMAN@UP.COM

JOE MCINTYRE
SR. MANAGER
MAIL STOP 0640
(402) 544-1525 C (402) 210-7064
JAMCINTY@UP.COM

WIRELESS & PROPERTY MANAGEMENT

TOM MCGOVERN
ASSOCIATE SYSTEMS ENGINEER
MAIL STOP 0640
(402) 544-6090 C (402) 871-4005
TMCGOVERN@UP.COM

ENGINEERING

GARY VOOGD
SYSTEMS CONSULTANT
MAIL STOP 0640
(402) 544-7425 C (402) 740-7859
GVOOGD@UP.COM

PAUL PINO
ASSOCIATE SYSTEMS ENGINEER
MAIL STOP 0640
(402) 544-3582 C (402) 203-6021
PAULPINO@UP.COM

REGIONAL CONSTRUCTION COORDINATORS

DARREN WALKER
TX, LA
(402) 501-4597 C (501) 295-2863
DWALKER1@UP.COM

JUAN (JOHN) RIVERA
AZ, NM, SOUTHERN NV
C (432) 284-0704
JRIVERA@UP.COM

CLARENCE STYVAR
CO, WY, ID,
CENTRAL UT, WESTERN NE
(402) 501-4571 C (402) 203-8732
CLSTYVAR@UP.COM

SHAWN RIGGS
NORTHERN CA, WA, OR,
C (530) 249-9924
SERIGGS@UP.COM

JAMES (DAVE) MOSER
NORTHERN NV, NORTHERN UT,
EASTERN CA
(402) 501-4053 C (530) 616-1279
JDMOSER@UP.COM

VICTOR MENDEZ
SOUTHERN CA
(442) 243-7117
VRMENDEZ@UP.COM

BRIAN MCCALL
EASTERN NE, KS, MO,
OK, WESTERN IA
(402) 501-4584 C (402) 312-2888
BGMCALL@UP.COM

PAYTON LEIGH
WI, IL, MN, EASTERN IA,
AR, TN
(402) 233-1630 C (815) 535-8401
PCLEIGH@UP.COM

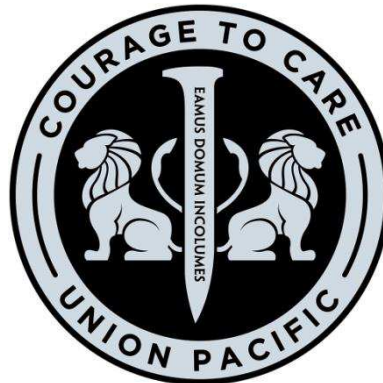

TABLE OF CONTENTS

TABLE OF CONTENTS	1
INTRODUCTION	2
1 ADMINISTRATIVE PROCEDURES	2
1.1 PROCEDURES FOR THE PLANNING OF NEW FIBER OPTIC CONSTRUCTION UTILIZING THE RAILROAD ROW	2
2 ENGINEERING PROCESS	4
2.1 PLAN SUBMITTALS	4
2.2 NOTIFICATIONS:	5
3 PROJECT SAFETY, PLAN, DESIGN AND CONSTRUCTION OF CUSTOMER FIBER OPTIC CABLE SYSTEMS	6
3.1 GENERAL PROJECT SAFETY	6
3.2 EMERGENCY RESPONSE PLAN	10
3.3 PERSONAL PROTECTIVE EQUIPMENT	11
3.4 TRAIN MOVEMENT AND WORKING NEAR TRACKS	13
3.5 RAILROAD FLAGGING/PROTECTION	13
3.6 PLANNING	15
3.7 DESIGN (General Requirements).....	17
3.8 DRAWINGS	20
3.9 DRAWINGS - MODIFICATIONS TO EXISTING FACILITIES.....	23
3.10 CONSTRUCTION.....	24
3.11 GENERAL FIRE PREVENTION SAFETY and HOT WORK PROCESSES	31
3.12 WORK EQUIPMENT	33
3.13 WORKING NEAR POWER LINES	33
3.14 TRENCHES AND EXCAVATIONS	34
3.15 TRENCHLESS INSTALLATION OF FIBER SYSTEMS	36
3.16 HOUSEKEEPING	40
3.17 BRIDGES, TUNNELS AND ABOVE GROUND INSTALLATIONS	41
3.18 WEATHER.....	42
3.19 REPEATER STATIONS (REGENS).....	43
4 DIG SAFELY – LOCATE ACCURATELY	44
5 DOCUMENTATION (AS BUILT DRAWINGS)	45
5.1 DESIGNER REQUIREMENTS	45
6 MAINTENANCE	47
6.1 EMERGENCY MAINTENANCE.....	47
6.2 REGULAR MAINTENANCE	48
7 DEFINITIONS	50
8 ABBREVIATIONS	55
9 APPENDIX	56
9.1 List of Exhibits:.....	56
9.2 References:.....	56
10 INDEX	57
11 NOTES	58

INTRODUCTION

The objective of this document is to ensure that Union Pacific Railroad (Railroad) commercial fiber systems and facilities along the Railroad operating corridors are installed safely, and to ensure that the requirements for such construction are communicated in a uniform manner to our communication company customers.

These specifications represent a collection of safe working processes, best practices and procedures that are annually reviewed and updated as an integral component of the Railroad's fiber optic program. They are provided only as a guideline for the successful completion of fiber optic installations on Railroad right-of-way ("ROW") and are not to be taken as authority to construct without prior review and approval by the appropriate Railroad representative.

Any items not covered specifically herein are to be in accordance with American Railway Engineering and Maintenance-of-Way Association ("AREMA") standards and recommended practices, subject to the approval of the Railroad. Exceptions to these specifications will be considered on a case-by-case basis. Railroad reserves the right to change any of the specifications in this document without prior notice. Definitions used in this document follow in Section 7 – Definitions. Dimensions are given in Standard form with metric units in parentheses.

1 ADMINISTRATIVE PROCEDURES

1.1 PROCEDURES FOR THE PLANNING OF NEW FIBER OPTIC CONSTRUCTION UTILIZING THE RAILROAD ROW

- 1.1.1 Appropriate Railroad personnel will cooperatively work with the fiber optic company ("FIBOCO") to generate the necessary documents to commence feasibility and preliminary engineering design of the proposed project. (Refer to Exhibit A – Contacts)
- 1.1.2 Contact the Railroad's Commercial Telecommunications agreements manager at (402) 544-0577 as soon as possible to determine whether this work will require:
 - a) An addendum to an existing agreement.
 - b) Modification of an existing agreement,
 - c) Negotiation of a new agreement, or
 - d) Creation of a new license agreement.
- 1.1.3 If additional ROW is to be occupied by a FIBOCO with pre-existing facilities on the ROW, such fiber optic facilities including the precise limits of this additional ROW (within 1/10 mile) must be identified and documented within

the appropriate agreement. Once the assigned Railroad representative has approved the construction plans (Approved Plans), Railroad will prepare the appropriate agreement document(s) and submit to the FIBOCO for execution.

- 1.1.4 After the FIBOCO has executed the agreement documents, counterparts have been delivered to Railroad's Director - Commercial Telecommunications, and any required payments have been received by Railroad, arrangements will then be made with Railroad's assigned Construction Coordinator (CC) to coordinate the start of work activities.
- 1.1.5 Plan approval, agreement execution and payment do NOT constitute approval to go to work.
- 1.1.6 The FIBOCO is approved to go to work when the following requirements have been met:
 - a) All permits/agreements are in place.
 - b) Plans are approved, and each work group has a stamped and dated copy.
 - c) The agreement has been executed and payment has been received.
 - d) FIBOCO has obtained a Notice to Proceed from the Commercial Telecommunications agreements manager.
 - e) The CC (s) have been contacted, participated in a pre-construction meeting, established necessary flagging protection and concurred with a start date for the work.
 - f) All field personnel are properly Railroad safety trained.
 - g) FIBOCO has secured a Railroad issued dig ticket through www.up.com/cbud for planned work, or 800-336-9193 for emergencies such as fiber cuts or derailments.
- 1.1.7 PLEASE NOTE: Accessing Railroad property without an agreement is considered trespassing. FIBOCO employees, consultants, contractors or other representatives must have an executed agreement to access Railroad property for site review, survey, engineering and construction. Contact the Railroad Commercial Telecommunications agreements manager for more information.

2 ENGINEERING PROCESS

This section outlines the engineering review process performed by the Fiber Optic Engineering Group, on behalf of Railroad.

2.1 PLAN SUBMITTALS

- 2.1.1 New or revised plans shall be submitted to the Fiber Optic Engineering Group for review and approval (Refer to Section 3.8 - Drawings). Current contact information can be found in Exhibit A of this manual or obtained through the Railroad's web site: <Http://www.up.com/fiber>. (Copy and paste into your browser.) After initial contract agreements have been implemented (Refer to Section 1.1.2) for new fiber builds, contact the Fiber Optic Engineering Group to coordinate initial site reviews, Valuation Map (Val Maps) requests, procedures for preparation, and submittal of plans for review and approval (Refer to Sections 3.6 – Planning, 3.7 – Design and 3.8 - Drawings). Once the plans have been reviewed and approved, an approval letter will be sent to the appropriate FIBOCO contact detailing the next steps necessary that will need to be implemented (Refer to Sections 1.1.3 through 1.1.6).
- 2.1.2 Modifications to existing fiber systems: For new laterals and relocations, etc, the plans will need to be submitted to the Fiber Optic Engineering Group for review and approval. Upon completion of the plan review, an approval letter will be sent to the FIBOCO, along with a copy of the Approved Plans. If the agreement needs to be modified, or if a new agreement needs to be made, the approval letter will indicate the process that needs to be followed. (Refer to Sections 1.1.3 through 1.1.6)
- 2.1.3 All plans are signed and date stamped with the same date as the approval letter. These plans are valid for one (1) year from date of issue. If the project has not been started by this time; the plans will need to be re-submitted for re-approval.

2.2 NOTIFICATIONS:

- 2.2.1 The Fiber Optic Engineering Group will notify the fiber carriers, who have rights to be on the ROW, of new and impending Railroad or third-party projects, including but not limited to bridges, drainage improvements, sidings, signals, yards, terminals, industry tracks and roadways. Not all projects will have notification letters sent. When a carrier (who may or may not have been notified) has a question regarding a potential project, please contact the Fiber Optic Engineering Group, found in Exhibit A.
- 2.2.2 Once the FIBOCO has been notified of a project on Railroad right of way, it must promptly identify if its system(s) will be impacted, which may include potholing to determine depth. This investigation will be carried out at the FIBOCO's expense. The exception is on public projects where the project sponsor may be liable for the expenses. Every effort must be made to not delay Railroad projects.
- 2.2.3 Any modifications to FIBOCO systems required to accommodate Railroad or third-party construction projects must be documented and approved through the Railroad plan submittal process outlined in this section.

3 PROJECT SAFETY, PLAN, DESIGN AND CONSTRUCTION OF CUSTOMER FIBER OPTIC CABLE SYSTEMS

It is Railroad policy to conduct its business in a manner that addresses the safety of employees, contractors, customers and the communities we serve. Railroad will strive to prevent all incidents, accidents, injuries and occupational illnesses through the active participation of all stakeholders. Railroad employees are committed to continuous efforts to identify and manage safety risks associated with their activities. All personnel working on Railroad ROW are held to this same standard of safety.

3.1 GENERAL PROJECT SAFETY

- 3.1.1 Any person, contractor, or company who wishes to work on the ROW is governed by On Track Safety (Refer to Section 7 – Definitions.) Where Railroad procedures are more stringent, those procedures will apply. Any work performed without obtaining proper authorization may permanently jeopardize your ability to be allowed on the ROW.
- 3.1.2 ALL ACCIDENTS ARE PREVENTABLE!!! Workers are responsible for their safety and are accountable for their behavior on the ROW. Take every precaution to prevent injury to yourself, other workers and the public. Report immediately any dangerous condition or unsafe practice to the CC or appropriate Railroad representative. Be aware of, and work within, the limits of your physical capabilities.
- 3.1.3 Safety is always the top priority. Safety takes precedence over deadlines, production schedules, and all other considerations. Always take the safest course when uncertainty arises. Accidents are almost always the result of carelessness, unsafe practices, or lack of attention.
- 3.1.4 A FIBOCO representative with decision-making authority, other than its lead contractor, is expected to be on each job site.
- 3.1.5 Work in a manner which will **not** disrupt Railroad operations, including, but not limited to, train movements, facilities maintenance, and communications.
- 3.1.6 The FIBOCO is responsible to ensure that all safety precautions are followed by its own employees and those of its contractors and subcontractors, including appropriate translations as necessary to ensure complete understanding. This includes night security personnel. (Refer to Section 3.5 – Railroad Flagging/Protection)

- 3.1.7 Keep the job site free from safety and health hazards. This includes, but is not limited to, installing proper barricades or warning devices, placing materials and equipment so that they do not create hazards and keeping roads clean of mud and debris.
- 3.1.8 Maintain infrastructure and equipment, establish documented safety guidelines, provide training and conduct operations in a manner aimed at safeguarding people and property.
- 3.1.9 Ensure that workers are competent and adequately trained in all safety and health aspects of the job. Only Railroad authorized personnel, as specified by agreement with the Railroad, are allowed on the ROW.
- 3.1.10 All FIBOCO personnel and its contractor(s) are required to complete safety training offered on line on the Union Pacific Commercial Telecommunications group website (up.com/fiber), in addition to being governed by On Track Safety as required by the Federal Railroad Administration (FRA. Upon satisfactory completion of Railroad safety training, workers will be issued an annual "Safety Trained" sticker for their hard hats that must be displayed at all times while on the ROW.

SPECIAL NOTES:

- a) Safety stickers are non-transferable. If stickers are prohibited on hard hats due to regulatory requirements, they need to be displayed by other means.
 - b) Internet based Safety/Security courses such as "Contractor Orientation" and "e-RAILSAFE" complement, but do not substitute for, the Union Pacific Commercial Telecommunications safety training program.
- 3.1.11 Additional safety training will be required for any persons who will be working on bridges, tunnels or other above ground installations. These procedures are outlined in Section 3.18.
 - 3.1.12 All FIBOCO representatives and contractors, including surveyors, are required to have proper documentation to be on the ROW, otherwise they will be considered trespassing. Railroad crews will report to the RMCC suspicious and/or undocumented persons on the ROW.

3.1.13 Job briefings are required prior to beginning work each day. Additional job briefings are required when working conditions or procedures change, or other workers enter the working limits. If a person(s) arrives after work has begun and missed the original job briefing, then another job briefing must be performed as soon as possible.

Minimum information must include:

- a) An explanation of the work to be performed. Include what, why, when, where and who. What safety precautions are necessary?
- b) A designation of who is the Employee in Charge (EIC), and if working limits overlap, who will be the sole EIC.
- c) A discussion of all potential hazards.
- d) The issuance of assignments and appropriate explanations.
- e) An understanding of the safest course.
- f) The designated work zones.
- g) A designated place of safety where workers clear for trains.
- h) The issuance of instructions.
- i) Completion and complete understanding of the Railroad Emergency Response Form (Refer to Exhibit T – Railroad Emergency Response Form)
- j) Establishment of translation for non-English speaking members of the work group.

3.1.14 Work is permitted for a maximum of ten hours each day between sunup and sundown. Good visibility is required at all times work is performed. No work is permitted on Sundays or Railroad holidays. Railroad holidays are as follows:

New Years Day – Martin Luther King Day and/or Presidents Day – Good Friday – Memorial Day – Independence Day – Labor Day – Thanksgiving – Day after Thanksgiving – Christmas Eve – Christmas Day – New Years Eve.
Note: Various Railroad Service Units may recognize other holidays and establish other work periods. You will be required to honor these holidays and work periods.

3.1.15 Firearms of any kind are strictly forbidden.

3.1.16 Using, possessing, or working under the influence of alcohol and/or drugs is not permitted. This includes prescription drugs that cause drowsiness.

3.1.17 Smoking is prohibited on all company property, including mechanical facilities, along the ROW, in office buildings and all service unit facilities. This includes company vehicles, equipment and in Railroad sponsored meetings held at off-site locations.

- 3.1.18 The use of cell phones and computers is restricted. When cell phone use is allowed, workers must follow all applicable federal, state and local laws. Use of cell phones (including their PDA functions) and computers is governed by the following:
- a) Before using a cell phone or computer, determine that it's safe to do so.
 - b) FIBOCO representatives must not use cell phones when close to any track or when in close proximity to workers or equipment working on or off-track. If use of phone is necessary, move to outer edge of the ROW.
 - c) Cell phone use is allowed in the performance of prearranged job duties or in an emergency.
 - d) Use of cell phones while operating a motor vehicle is permitted when:
 - i. A hands-free device is used, and voice activated dialing or speed dialing is used, or
 - ii. Stopped on other than a roadway.
- 3.1.19 It is imperative that the FIBOCO document every accident and personal injury on the ROW. (Please review Section 3.2.7. The FIBOCO must provide a final report for each incident to the Director - Commercial Telecommunications. Photographs should be included when available and appropriate.
- 3.1.20 It is the FIBOCO's responsibility to ensure that any product, waste, or other refuse is handled and/or disposed of in accordance with all applicable governmental regulations and Railroad policies. It is the FIBOCO's responsibility to prevent fuel or lubricants from being released into the environment. In the event of a spill or release into the environment, notify the RMCC immediately at 1-888-UPRR-COP (1-888-877-7267).
- 3.1.21 The FIBOCO is responsible for any of its contractors and their subcontractors to be knowledgeable of the policies of Railroad, and for ensuring all work to be in compliance with these specifications. Only Railroad authorized personnel, as specified by agreement with the Railroad, are allowed on the ROW. All Railroad authorized personnel working within the ROW must be willing and able to supply proof of identity when and if requested by Railroad personnel.
- 3.1.22 It is the FIBOCO's responsibility to inform Railroad, in writing, of any name, ownership or address change.

- 3.1.23 Do not disclose information about Railroad to anyone that does not have a “need to know”. If you encounter someone on the ROW and are unsure how to deal with them, contact your authorized Railroad representative. Never take action that will put you in harm’s way. Report all trespassers or suspicious people to the RMCC.
- 3.1.24 The Railroad has locations in which Remote Controlled Locomotives (RCL) operate. These areas are identified as RCL Zones. Within these zones, typically found in yard locations, positive train protection must be employed which will be coordinated by the CC.

3.2 EMERGENCY RESPONSE PLAN

- 3.2.1 Keep a list of local emergency phone numbers and addresses accessible to all employees at the job site. Include Railroad contacts with this list. (Refer to Exhibit T – Railroad Emergency Response Form)
- 3.2.2 Report by the first available means of communication any accidents, personal injuries, defects in tracks, bridges, tunnels, signals, utilities or communication facilities; or any unusual condition that may affect the safe operation of the Railroad or installed fiber optic systems.
- 3.2.3 Do everything possible to care for injured persons. Respond quickly, effectively, and with care to emergencies, accidents, or incidents in cooperation with authorized government agencies.
- 3.2.4 Maintain proper first aid kits on the job site at each crew location. Keep first aid kits in plain sight and accessible.
- 3.2.5 If a personal injury accident, loss of life or damage to property occurs, secure the names of all persons involved, including all persons at the scene when the accident occurred and those who arrived soon after.
- 3.2.6 Avoid derailment sites. If you do not have to be there, move to a safe distance. If FIBOCO employees or contractors do have to be in the area, obtain permission from the appropriate Railroad representative in charge before beginning work at the site. Be careful when working around a derailment. Hazardous materials may be present. Some may even be lethal if inhaled or absorbed through the skin.

- 3.2.7 Immediately report to the RMCC at 1-888-UPRR COP (1-888-877-7267) any hazardous materials encountered or unearthed during construction or maintenance of the fiber system on the ROW.
- 3.2.8 Report any damage to Railroad or outside property immediately to the CC. All accidents or personal injuries must be reported immediately to the CC. The FIBOCO must document every accident and personal injury on any Railroad property, and provide a report of each incident to the CC.

3.3 PERSONAL PROTECTIVE EQUIPMENT

3.3.1 The following equipment is mandatory when working on the ROW:

- a) A hard hat conforming to ANSI national standard Z89.1. Designer hard hats are unacceptable, (e.g. cowboy hats). Hard hats should display the contractor's company logo or name, unless otherwise authorized by the Railroad.
- b) Safety glasses conforming to ANSI national standard Z87.1 (FDA approved prescription glasses, or nonprescription safety glasses).
- c) Sturdy safety-toe footwear. All safety toe footwear must meet ANSI Z41.1, Standard Class #75. They must be lace-up boots. Slip-on boots, tennis shoes, and regular low cut casual shoes are not permitted.
- d) Hearing protection when appropriate.
- e) Highly visible orange outer wear that includes reflective striping conforming to ANSI Class II outer wear.
- f) Welding or other hot work activities require additional protective clothing as appropriate.

3.3.2 Proper attire is required when working on ROW that allows you to perform your duties efficiently and safely. Employees must wear trousers which cover the legs.

- a) Clothing must not:
 - i. Not be red in color.
 - ii. Interfere with vision, hearing and free use of hands and/or feet.
 - iii. Block peripheral vision. When hooded sweatshirts and/or coats or similar type clothing are worn, they must be secured around the face to prevent the blocking of peripheral vision.
 - iv. Be torn, baggy, or ragged.
 - v. Be so loose that it will snag easily or catch on railroad cars, engines, tools, machinery or other equipment but must allow freedom of movement.

- vi. Be worn so it creates the possibility of being caught or may affect one's safe performance of their duties, i.e. neckties or similar clothing.

b) Shirts must:

- i. Have at least quarter-length sleeves and cover the back, shoulders, chest and abdomen.
- ii. Provide protection from sun, insects, abrasions or scratches.
- iii. Be buttoned, if a button front style.
- iv. Have tails tucked. Anyone working around equipment or moving machinery in which a shirt might become entangled must have their shirt tails tucked into their trousers.

3.3.3 Observe safety practices that eliminate slips, trips and falls. Avoid objects, obstructions, holes and openings and be alert to underfoot conditions. Aisles, stairways and walkways must be kept free of tools, trucks, materials, equipment and obstructions.

a) Precautions to avoid slips, trips and falls:

- i. Perform your work to avoid creating hazards.
- ii. Maintain good housekeeping.
- iii. Clean up spills.
- iv. Erect barricades, signs, or cones where appropriate.

b) Precautions to avoid slips, trips and falls:

- i. On snow, ice, wet spots or other hazards caused by inclement weather, use appropriate footwear and accessories and/or spread sand/salt mixture (as appropriate) on ice before proceeding when icy conditions exist.
- ii. Avoid slick surfaces such as recently washed or waxed floors, and either oil, grease or soap on the walkway.
- iii. When walking, keep your eyes on the pathway and if hazardous under foot conditions exist.
- iv. Keep your hands out of pockets for balance.
- v. Take short, deliberate steps with toes pointed outward.
- vi. When stepping over objects, such as rails, be sure your front foot is flat before moving your rear foot.
- vii. Do not run except when necessary to prevent injury to you or others.

3.4 TRAIN MOVEMENT AND WORKING NEAR TRACKS

- 3.4.1 No work is allowed within 50 feet (15.24 meters) of the center line of the nearest track while trains are passing the work site. Always stand as far back as possible to prevent injury from flying debris or loose rigging. Also, observe the train as it passes and be prepared to take evasive action in the event of an emergency.
- 3.4.2 NEVER remain in a vehicle that is within 50 feet (15.24 meters) of a passing train, and do not drive near moving trains. Move vehicles away from the tracks at least 50 feet (15.24 meters) or park the vehicle away from the tracks and walk to a safe distance whenever trains pass.
- 3.4.3 Never stand on or between adjacent tracks in multiple track territory when a train is passing.
- 3.4.4 Never walk, stand or sit on the rails. The rail surface can be extremely slippery. Step over rails when crossing tracks.
- 3.4.5 Stay away from track switches. The switch points can move unexpectedly with enough force to crush ballast rock! Stay away from any other railroad devices you are unsure of.

3.5 RAILROAD FLAGGING/PROTECTION

- 3.5.1 Certain projects will require the assistance of a qualified Railroad flagger. A minimum of three (3) weeks advance notification of the Railroad is required before entering the ROW for non-emergency situations so that flagging protection can be DETERMINED BY THE RAILROAD and secured. Availability of flaggers is not guaranteed; however, work may not progress until appropriate flagging has been arranged. For emergency situations contact the Railroad immediately at 1-800-336-9193.
- 3.5.2 A Railroad flagger may be required for protection any time FIBOCO personnel are on the ROW. A Railroad flagger is not authorized to regulate train frequency or train speeds but is provided to ensure that the track is cleared for approaching trains. Flaggers are not inspectors and cannot recommend or approve work practices or product. However, flaggers, as authorized Railroad representatives, can shut down projects for work practices that appear to be unsafe.

- 3.5.3 Every workday must begin with a job briefing. When utilizing a flagger, everyone must have a working knowledge of the flagging limits, time limits and location to which everyone will clear for any train movements. (Refer to Section 3.1.12)
- 3.5.4 Effective communication between the FIBOCO, the contractor, the CC and the Railroad flagger is imperative! The Railroad flagger will be responsible for clearing any movement of workers and equipment near the tracks, no matter how minor.
- 3.5.5 Do not interfere with a Railroad flagger who is communicating by radio with the dispatcher or other railroad employees. Wait until the Railroad flagger is finished and able to give you full attention. **DO NOT ASSUME A MOVE IS CLEARED BY SOMETHING OVERHEARD ON A RADIO CONVERSATION.**
- 3.5.6 The Railroad flagger providing protection for train movement for a construction crew is restricted by time and location limits given by train dispatchers, and the flagger may not be able to assist crews outside of those limits.
- 3.5.7 Take the time to prepare your schedule for each day in advance and discuss the operations with the CC so protection can be arranged. Protection may need to be secured by noon on the day before (or sooner) to avoid job delays. Fencing in lieu of flaggers may be used at the discretion of the CC.
- 3.5.8 FIBOCO crew locations and the number of crews may be restricted depending on Railroad Flagger availability, job site access and adequate radio communications.
- 3.5.9 Do not begin work late in the day if it cannot be completed or secured to the satisfaction of the CC.
- 3.5.10 A Railroad Flagger is required any time there is a bore underneath active railroad tracks.
- 3.5.11 The FIBOCO will be billed for the flagger. If the FIBOCO or its contractor cancel or postpone a project without adequate advanced notice, the FIBOCO may still be billed for the number of days the flagger was scheduled to be at the job site
- 3.5.12 The Railroad has begun using trained contractors to flag for fiber optic projects. The FIBOCO will be required to execute an agreement with the contracting firm for payment of the flagging costs incurred.

3.6 PLANNING

- 3.6.1 Obtain and execute a "Fiber Optic Survey Agreement" or "On and About" prior to entering the ROW (Refer to Section 1 – Administrative Procedures)
- 3.6.2 Coordinate the engineering criteria, from the preliminary route inspection through the actual route design, with the Fiber Optic Engineering Group (Refer to Section 2 – Engineering Process)
- 3.6.3 Railroad will furnish one electronic set of available ROW maps (Valuation or Track Maps), bridge plans and other necessary plans of the proposed route as specified in the "Fiber Optic Survey Agreement". Railroad does not guarantee or warrant information on ROW maps. **It is the responsibility of the FIBOCO to verify property ownership.**
- 3.6.4 A Fiber Optic Engineering Group member will participate and accompany the FIBOCO representatives during a preliminary route inspection to address any special design considerations and constraints.
 - a) Several weeks advance notice may be necessary to arrange and schedule a route inspection requiring the use of a hy-rail vehicle.
 - b) During the route inspection, mark in red on copies of the Railroad maps or condensed profiles, the proposed fiber system route agreed to by both companies. Use this document in the preparation of construction drawings.
- 3.6.5 When planning a fiber system project:
 - a) Identify and note on maps any wetlands, and potential impact of the project on such areas.
 - b) Note vegetation, property uses and topography not indicated on maps.
 - c) Note cuts and fills.
 - d) Note soil conditions.
 - e) Identify potential track crossings, particularly under-track bores.
 - f) Note locations of railroad structures and potential obstructions.
 - g) Document surrounding area by use of digital photography as conditions permit.
- 3.6.6 You are governed by all Railroad instructions and regulations, in addition to On Track Safety, while conducting preliminary investigations and route surveys on the ROW, per Sections 3.1 – General Project Safety, 3.2 – Emergency Response Plan and 3.3 – Personal Protective Equipment.

- 3.6.7 The Railroad requires at least two persons per survey crew.
- 3.6.8 The use of measuring wheels will be allowed only over the top of proposed running lines. Use of the wheel within 10 feet (3.05 meters) of the nearest rail will require use of a flagger. Never deface any railroad property. This includes marking property to establish stationing during survey, design or construction.
- 3.6.9 A Railroad issued dig ticket will be required prior to excavation. For planned work, obtain a ticket at www.up.com/cbud. For emergencies call 800-336-9193. If you plan to place anything that penetrates the ground more than 18 inches (48 centimeters), a locate may be required. This includes installing marking stakes or signs.
- 3.6.10 Obtain permission to occupy the property or right-of-way of landowners other than the Railroad. It is the FIBOCO's responsibility to obtain any permits, if required.
- 3.6.11 You are expected to conduct yourself in a controlled and respectful manner on the ROW.
- 3.6.12 Special permission from the Director - Commercial Telecommunications is required for the use of multi-purpose utility vehicles (MUV's) on the ROW.
- a) MUV's are to be operated as a work vehicle, adhering to all safety instructions and operating practices recommended by the manufacturer.
 - b) Speed of MUV vehicles should never exceed walking speed and cross tracks only at approved crossings, and never be operated closer than 25' (7.62 meters) to the track.
 - c) An MUV is never to be left running when unoccupied by the driver.
 - d) Each occupant must be properly seated and seat belted.
 - e) An MUV must not be used in conjunction with other vehicles or used to tow.
 - f) Avoid uneven terrain, keeping on access roads unless otherwise approved.
- 3.6.13 The use of unmanned aircraft (drones) will be determined on an individual basis.
- a) May not be used without prior Railroad approval.
 - b) May not be flown over or near trains
 - c) Are governed by 14 CFR 107.65

3.7 DESIGN (General Requirements)

- 3.7.1 All projects on Railroad property must be field engineered. Office engineered plans without field verification are not acceptable. Coordinate field reconnaissance with a Fiber Optic Engineer or CC.
- 3.7.2 Detail all proposed fiber facilities including lines, repeater sites, junctions, and structures. Visit www.up.com/cbud to obtain a dig ticket for fiber locates or field meets with existing fiber optic carriers.
- 3.7.3 Locate and identify buried utilities and other potential obstructions. (Refer to current edition of Common Ground Alliance Best Practices)
- 3.7.4 The fiber system is to be installed near the outer limits of the ROW. Design the fiber system running line to be as straight as possible while maintaining a consistent distance from the center line of the nearest track. Design and detail all installations on, over, or under Railroad property of durable materials designed for long service life and relatively free from routine servicing and maintenance. Conformance with current applicable material specifications and codes is mandatory. These include but are not limited to lines, repeater sites, junctions and structures.
- 3.7.5 Design the fiber system to be installed on the field side of all Railroad structures, including bridges, signal facilities, buildings and platforms.
- 3.7.6 If the fiber system has to be placed under an existing signal or communication structure, place the system a minimum of 10 feet (3.05 meters) under natural ground. This extra depth may also be required in "signal sensitive areas" such as interlocking or control plants.
- 3.7.7 If the fiber system has to be located under (vertically) existing signal or communication wires, a minimum 2 feet (.61 meters) of separation is required.
- 3.7.8 Fiber optic cable must not be installed within 5 feet (1.52 meters) horizontally of Railroad underground power or signal power lines, unless suitably insulated. There may be instances where fiber and power can be in the same trench, such as access to a tower site.
- 3.7.9 If the fiber system is designed within 30 feet (9.14 meters) of a center line of the nearest track or structure of any type, excavations within this area may require shoring designed to include train or structure surcharges in conformance with the Union Pacific and Burlington Northern "Guidelines for Temporary Shoring". In such cases, submit shoring plans with calculations, stamped by a licensed civil engineer, to the Fiber Optic Engineer for approval prior to construction. The submittal can be made by the contractor after the project has been awarded; however, the project may be delayed waiting for

approvals. (Refer to Section 3.14 - Trenches and Excavations and Exhibit I – General Shoring Requirements)

- 3.7.10 Do not design fiber system components that create stumbling hazards on the ROW. Placement of marker signs in Railroad access roads is not allowed. Marker signs should be installed at the outer limits of the ROW.
- 3.7.11 Design the fiber system to be installed a minimum of 42 inches (1.07 meters) below natural ground, except as noted herein. Warning tape should be placed above the buried facility. (Refer to Exhibits D – Cable Depth Around Culverts & N – Rock Trench)
- 3.7.12 In the event local ground conditions prohibit the placement of the fiber system at a depth of at least 42 inches (1.07 meters), the fiber system must be encased, and specific approval by the Fiber Optic Engineer is required. If rock is encountered and prevents a depth of 42 inches (1.07 meters), the fiber system must be cut into the rock at a depth of 18 inches or greater, provided proper grouting and cable protection is used. Cutting the rock less than 18 inches (46 centimeters) requires special permission from the Fiber Optic Engineer (Refer to Exhibit N – Rock Trench)
- 3.7.13 Design the fiber system to be buried a minimum of 60 inches (1.52 meters) below the bottom of all culverts on the ROW, or around the end of the culvert (field side) and 60 inches (1.52 meters) below the bottom of the cleaned-out ditch. Only after specific evaluation by the Fiber Optic Engineer will any system be allowed to be placed over the top of any culvert. (Refer to Exhibit D – Cable Depth Around Culverts)
- 3.7.14 Avoid the slope of cut or fill sections when designing the running line. Design the fiber system to run over the top of a cut section whenever possible. (Refer to Exhibit K – Installation on Top of Cut)
- 3.7.15 Do not design the fiber system to attach to Railroad bridges to cross waterways, highways, etc., unless no other feasible alternative exists and subject to the following:
 - a) Fully explore all other options before submitting requests to attach the fiber system to the bridge.
 - i. In no instance will the Railroad approve permanent attachment of the fiber system to a timber bridge, nor to the handrails of bridges.
 - ii. No bridge abutments or piers shall be allowed to be core bored. All attachments are to be placed around the abutments and/or piers.
 - b) Submit separate bridge attachment designs to the Fiber Optic Engineer for approval prior to construction. Include the following with your request:

- i. A full justification as to why it is necessary to make the attachment. Expedience or cost avoidance are generally not acceptable reasons.
- ii. Detail drawings indicating type and placement of supporting brackets, the size and type of fasteners and conduit.
- iii. Photos of the bridge, track, and the fill approaches to the bridge.
- iv. Details at and around bridge backwalls.
- v. A detailed work plan of the attachment process, including all proposed work equipment (such as rail mounted work equipment, cranes, and boom trucks) and all other mechanized equipment to be approved by the Fiber Optic Engineer prior to construction.
- vi. Design bridge attachments that will not delay future repair, replacement, and other construction to take place on or near the bridge (superstructure and substructure).
- vii. Include in the design extra cable in a protected facility near the bridge so the bridge can be raised if necessary and without delay to Railroad or FIBOCO operations.
- viii. Design the fiber system so it does not obstruct the bridge bearings. (Refer to Exhibit C – Bridge Definition)
- ix. Design the fiber system to be installed on the downstream side of the bridge.

3.7.16 Design hand holes, splice boxes, and manholes for appropriate loading conditions. In general, locations within 15 feet (4.57 meters) of center line of nearest track should be designed for a Cooper E80 surcharge, while all other installations should withstand AASHTO H-20 highway loading requirements, in addition to soil pressures. Installation of hand holes or manholes in yards and near heavy vehicular traffic areas may require concrete fill around the boxes. Include plans with typical hand hole and manhole details with the project plan submittal. More stringent design criteria may be required. All hand holes, splice boxes, and manholes should include several inches of ground cover for security purposes

3.7.17 Design hand holes and manholes to utilize a minimum of ROW corridor within the running line. Hand holes that allow cable slack should be placed at locations that allow Railroad maintenance and to minimize ROW disturbance. Hand holes and manholes used for splicing multiple duct systems need to be placed at the maximum distance from each other without clustering. (Refer to Exhibit P – Hand hole Location)

3.7.18 The design of hand holes, manholes and splice holes should not be within 100' (30.48 meters) of existing Railroad signal or communication buildings, facilities or existing regen compounds unless required for tying to the existing facility. (Refer to Exhibit P – Hand Hole Location).

- 3.7.19 Installation of fiber systems on pole lines within the ROW are reviewed on an individual basis.
- 3.7.20 Any overhead crossing of the track by the fiber system must adhere to the Real Estate process for Wire line Installation Procedures for Crossings per the address: http://www.up.com/real_estate/utilities/wireline/index.htm. (Cut and paste into your browser.)
- 3.7.21 Designs must comply with all Federal, State and/or Local Laws. A Storm Water Pollution Prevention Plan is required for disturbances greater than one acre.

3.8 DRAWINGS

- 3.8.1 Use RAILROAD METHODOLOGY FOR EQUATING FIBER OPTIC CABLE LOCATIONS TO RAILROAD TRACK AND RIGHT-OF-WAY MAPS. (Refer to Exhibit B - Methodology For Equating Fiber Optic Cable Locations To Railroad Track)
- 3.8.2 Drawing Submittal Minimum Requirements:(Refer to Exhibit S – Drawing Submittal Minimum Requirements). **Include completed checklist with submittal.**
- a) Title page indicating FIBOCO name, Railroad subdivision name and Mile Post, city (or city pair) and state(s).
 - b) Location map (can be included on title page).
 - c) Drawing format: 11”x17”, professionally prepared with computer-aided drafting (CAD).
 - d) Include copies of the original As-Built on all additions, moves and changes.
 - e) Standard detail sheets for hand holes/manholes, construction methods, marker signs, and other typical features.
 - f) Design drawings for all encroachments on ROW. (Details for work off ROW may be included for illustration or clarity but might not be included in the approved plan set.)
 - g) Include on the drawing set the FIBOCO project number for reference.

3.8.3 Submit construction plans at a scale of 1"=100' (2.54cm=30.48 meters) on 11"x17" paper. Details of construction in congested areas, or of construction that might impact Railroad facilities, such as at-grade crossings, under-track bores, regens or laterals will require a scale of 1" = 20' (2.54 cm = 6.05 meters). Exceptions must be approved by the Railroad's Fiber Optic Engineer.

3.8.4 Show the following on the design drawings:

- a) All necessary dimensions measured at right angles to the center line of the nearest track.
- b) The ROW limits, mainline track, sidings, spur tracks, Railroad mile markers, and Railroad station names, on both sides of the track, not just the side of the proposed fiber optic running line. Include Railroad stationing and, if used, corresponding FIBOCO stationing for each landmark. Station names are found on Railroad Val Maps for the route.
- c) Overpasses with road name and the Railroad's mile marker designations. Show bridge piers in relation to the Railroad's track, the fiber system and any culverts.
- d) All utility crossings (both underground and overhead), parallel underground utilities, pole lines, signals, signal houses, and other signal facilities.
- e) Public and private street and road crossings with street names. Show Railroad stationing and corresponding FIBOCO stationing at road center line.
- f) Rivers, fences, landmarks, and any other facilities, which will aid in identifying the fiber system location.
- g) The Railroad's dig ticket access: "For planned work visit www.up.com/cbud to obtain a dig ticket. This ticket will enable other fiber systems in the area to be located prior to excavation. This ticket must be **issued** no less than 48 hours prior to the start of work. For emergencies call 1-800-336-9193."
- h) Fiber system running line changes and bore locations indicating Railroad stationing and, if used, corresponding FIBOCO stationing.
- i) Conduit size and count, and fiber cable count.
- j) North arrows, scales and directional orientations on all sheets. Directional orientations include Railroad station names and/or mile post numbers in each direction at the edge of each sheet.
- k) County names.
- l) Railroad bridges and culverts with proper bridge/culvert number. (The bridge/culvert number is usually, but not always, related to the mile post location and can be found on the Railroad Val Map for the route, as well as on the structure.)
- m) Refer to Section 3.15 - Trenchless Installations of Fiber Systems, for plan submittal requirements.

- n) Hand holes: Refer to Section 3.7.16, 3.7.17 and 3.7.18 for hand hole plan submittal information.
 - o) Include “Union Pacific General Notes for Fiber Optic Installations.”
- 3.8.5 Include "original" and "revised" dates on all revised drawings.
- 3.8.6 Show the location of fiber system marker signs on the design drawings, and submit a detail of the sign, including color of the sign, for Railroad approval. This also applies to aerial marker signs.
- 3.8.7 Furnish drawings of each regen site along with the running line drawing. This drawing should show the same information mentioned in the previous sections. Other details to be included are: the distance from the regen building to the center line of all tracks, grade crossings, planned access and other facilities to the site. Also include plans for power supply required for the regen building including voltage, above ground clearances, below ground dimensions and building access. Drawings should also include all planned utility installations (such as gas, water, additional telecommunications) to the regen site. The site should be fully dimensioned, including overall dimensions for use in preparation of a site lease (where necessary).
- 3.8.8 Include all boring and casing details on the design drawings. This includes, but is not limited to, dimensions, bore pit locations, and casing specifications. Include a proposed bore profile for all under-track bores. This drawing must be to scale and not just a schematic representation.
- 3.8.9 Show on the design drawing(s) the reasons for deviations in the running line of the fiber optic cable system, such as steep banks, water crossings, ditches, obstacles, etc.
- 3.8.10 Railroad design requirements may be modified to permit installation at unique locations, but only after the FIBOCO has exhausted all alternatives, and the Railroad Fiber Optic Engineer has reviewed and accepted the plans. Submit, along with requests for deviations from these recommendations, detailed drawings depicting the deviations and the reasons for them.
- 3.8.11 All the dimensions in this manual have been given in English units with the metric unit equivalents in parentheses. However, all drawings submitted for Railroad approval need to have dimensions given in English units only.

3.9 DRAWINGS - MODIFICATIONS TO EXISTING FACILITIES

3.9.1 Cover sheet to include:

- a)** Project name.
- b)** Project Number.
- c)** Location Plan.
 - a. Any plan that includes enough information to locate separately.
 - b. Include nearby streets, hi-ways, towns, etc.

3.9.2 Include site plans

- a)** The engineered site plan, which shall include more detailed information than the location plan.

3.9.3 Submit a detailed plan of the new project.

- a)** Railroad Stationing.
- b)** References to existing hand hole/manhole designations. This will match the designation on the As-Built plans.
- c)** Include number of ducts.
- d)** Duct size(s).
- e)** Fiber strand count.
- f)** Distance along track.
- g)** Distance to edge of ROW and track center line.

3.9.4 Submit appropriate reference sheets.

- a)** Existing UPRR approved As-Built plan(s).
- b)** If existing duct is used on multiple sheets, include only first and last sheets, plus the sheet that indicates the nearest Mile Post.

3.9.5 For projects that include over pulling fiber cable in existing ducts for several miles, include a straight-line type drawing that generally includes:

- a)** Beginning and ending Mile Posts.
- b)** Beginning and ending Railroad Stationing.
- c)** Major street crossings along the route.
- d)** If the duct package is being modified in the middle of the project, identify which is new duct, and which is existing duct.
(Refer to Exhibit B-1 – Straight Line Drawing)

3.10 CONSTRUCTION

- 3.10.1 Proper documentation is required for working on any Railroad property. Each contractor/employee must maintain and provide, upon request, proper identification while on Railroad property. The following items must be maintained and provided to the CC prior to the pre-construction meeting and kept onsite for the duration of the project:
- a) Approved Plans by the Railroad Fiber Optic Engineer.
 - b) Railroad approval letter.
 - c) Damage Prevention procedures including location methods of other utilities.
 - d) Storm Water Pollution Prevention Plan (for disturbances greater than 1 acre) and other documents and permits as required by Federal, State and/or Local laws.
 - e) Railroad approved shoring plans (when shoring is required).
 - f) Emergency response plan. (Refer to Exhibit T – Railroad Emergency Response Form).
- 3.10.2 Any excavation, no matter how large or small, requires a Railroad issued dig ticket. Tickets for planned work can be obtained at www.up.com/cbud. These must be **issued** no less than 48 hours before excavation can begin. Make sure the applicable One-Call Center has been notified pursuant to each State requirement. (Please refer to current edition of Common Ground Alliance Best Practices)
- 3.10.3 The CC is the primary point of contact for the duration of the construction project.
- a) Complete arrangements with the CC for safety training and protection of construction operations prior to any construction activity on the ROW.
 - b) The starting date of construction may be affected by the availability of Railroad CC's and/or flaggers.
 - c) Contact and coordinate your activities with the CC at least 3 weeks prior to scheduling a project start date with a contractor.
 - d) The CC must be apprised of all project details during the duration of construction activities, whether or not he or she is present on site every day, and whether or not other UP employees become involved in the scope of the project (such as a flagger, a track manager, a construction manager, or others).
 - e) The FIBOCO will be charged for the CC's time on the project (including overhead, and travel). If the FIBOCO or its contractor cancel or delay a

project without adequate advanced notice, the FIBOCO may still be responsible for the scheduled days.

- 3.10.4 Affix the annual "Safety Trained" stickers to hard hats and have them visible when working on the ROW. (Refer to Section 3.1.9)
- 3.10.5 Follow the approved construction drawings.
 - a) Use only construction drawings which have the Railroad approval stamp on the cover sheet and initialed date stamps on all other sheets. The use of drawings not approved by the Railroad's Fiber Optic Engineer is strictly prohibited.
 - b) The conduit system is to be constructed at the designed location. Obtain approval from the CC for any deviation to the construction drawings and indicate such changes on the construction drawings.
 - c) The FIBOCO must have a representative available, other than the lead contractor, who has decision-making authority for any derivations from plan.
- 3.10.6 Install the fiber system a minimum of 42 inches (1.07 meters) below ground, except as noted herein.
- 3.10.7 Mechanized construction within 60 inches (1.52 meters) of existing facilities requires coordination of mechanized construction methods with each affected facility owner.
- 3.10.8 Install the fiber system a minimum of 60 inches (1.52 meters) below the bottom of all culverts on the ROW, or around the end of the culvert (field side) and 60 inches (1.52 meters) below the bottom of the cleaned-out ditch, whichever is greater. (Refer to Exhibit D – Cable Depth Around Culverts and Ditches).
- 3.10.9 Do not install the fiber system in the slope of cut or fill sections, and do not bench any cut or fill sections. Locate the fiber system over the top and on the field side of the back-slope of a cut section whenever possible. (Refer to Exhibit G – Conventional Fill Installation)
- 3.10.10 In the event the fiber system has to be located in the ditch, place the system a minimum of 60 inches (1.52 meters) beyond the toe of the slope and a minimum of 60 inches (1.52 meters) from the bottom of the existing flow line. This 60" depth should extend at least 50 feet in each direction from the center line of the culvert. The FIBOCO may want to consider placing the fiber system at extra depth and/or in protective casing for protection when Railroad personnel clean the ditch. Also, place the warning tape so that it is not disturbed during normal ditch cleaning by the Railroad.

- 3.10.11 Stabilize any waterways that have been plowed or cut. Use riprap or other approved erosion control methods.
- 3.10.12 Encase in galvanized steel pipe or black iron pipe [Specified Minimum Yield Strength of 35,000 psi (241,318 kPa) or above] all fiber system lines under tracks at depths less than 10 feet. Place casings a minimum of 60 inches (1.52 meters) below the base of rail or natural ground, whichever is greater. Use Railroad approved installation methods.
- 3.10.13 In some cases plastic pipe may be used as a casing instead of steel. Design of plastic casing will have to conform to the design methods in the AREMA Manual Chapter 1, Section 4, Culverts.
- 3.10.14 Extend the casing a minimum of 30 feet (9.14 meters) from the center line of nearest track, measured perpendicular to the track, or longer, to stay out of cuts and/or fills. (Refer to Section 3.7 Design)
- 3.10.15 For casing requirements at depths greater than ten feet (3.05 meters) below base of rail, refer to Section 3.15 - Trenchless Installation of Fiber Systems.
- 3.10.16 All boring operations are subject to Section 3.15 – Trenchless Installation of Fiber Systems.
- 3.10.17 No equipment is allowed on any track ballast section.
- 3.10.18 Do not foul the track ballast with dirt or other foreign materials, such as spoil piles.
- 3.10.19 Do not store or place equipment, supplies, materials, tools, or other items within 25 feet (7.62 meters) of the center line of the nearest track, or within 500 feet (152.4 meters) of road crossings.
- 3.10.20 Start clean-up and restoration of the ROW immediately after the fiber system installation in each construction area and continue on a daily basis as the project progresses until complete. Ensure that any stumbling hazards are removed immediately. Railroad property disturbed by the installation, maintenance, removal and relocation of fiber facilities is to be kept at a minimum.
- 3.10.21 Remove any brush or items that cannot be chipped to 1 inch (2.54 centimeters). At the discretion of the CC, the contractor may have the option of chipping trees and brush generated in construction to 1 inch (2.54 centimeters) in size and blowing onto the ROW (away from the ballast section!). Take care not to foul the ballast, block ditches or culverts, or otherwise impede drainage.

- 3.10.22 Compact all backfill in excavations and trenches to 95% maximum dry density as defined in ASTM Standard D698. Use clean, suitable backfill material. Install in six-inch lifts and compact.
- 3.10.23 Install only Fiber Optic Engineer approved bridge attachments incorporating the following:
- a) Install extra cable in a protective facility near the bridge so the bridge can be raised if necessary and without delay to Railroad operations.
 - b) Install the fiber system so as not to obstruct the bridge bearings. (Refer to Exhibit C – Bridge Definition)
 - c) Exercise care in trenching between the toe of the roadbed slope and bridge backwalls, typically by hand-digging or dry boring.
 - d) Torch cutting or welding of bridge members is not allowed. Drill holes required for bracket attachment.
 - e) If brackets must be removed from a bridge, do not torch cut bolts. After removing the bracket, insert a bolt in the open hole and paint with galvanized paint. If the bridge is concrete, cut the bolt flush with the concrete surface.
 - f) Touch-up any scratched galvanized bridge surfaces, including bracket attachments, with galvanized paint.
- 3.10.24 Fall protection conforming to all Federal Railroad Administration and OSHA regulations is required for work performed on all bridges and above ground installations. (Refer to Section 3.18 – Bridges, Tunnels and Above Ground Installations)
- 3.10.25 Install hand holes, splice boxes, and manholes per the requirements of Sections 3.7.16, 3.7.17 and 3.7.18. Install them so as not to create a stumbling hazard or to interfere with Railroad operations. Installation of hand holes or manholes in yards and near heavy vehicular traffic areas may require concrete fill around the boxes. Additional soil cover may be required for security purposes. (Refer to Exhibit P – Hand Hole Location)
- 3.10.26 Railroad signal personnel will locate, remove, and replace all guy wires on Railroad pole lines, if required.
- 3.10.27 Coordinate work on Railroad poles with the CC.
- 3.10.28 Follow applicable state and national electric codes for all pole work.
- 3.10.29 Obtain approval for all wire drops and splice locations from the prior to construction.

- 3.10.30 Obtain daily permission from the CC to climb the Railroad's poles to hang the fiber system. Ensure all power lines on the poles have been de-energized. Check the poles for structural integrity before climbing. Use climbing equipment conforming to OSHA regulations. In addition, comply with federal, state, and local laws and regulations.
- 3.10.31 Do not throw trash into any excavations.
- 3.10.32 Contain all construction-generated waste material and remove it to an approved disposal site. This includes, but is not limited to, excavated foundations, old dump sites, debris, concrete or masonry obstructions, organic matter, rocks, and boulders.
- 3.10.33 Remove all abandoned fiber system facilities from the ROW. Coordinate the method of cable removal with the assigned CC. Be advised: if the Railroad allows any abandoned cable to remain in place, the FIBOCO is not released from liability for damages to the Railroad or other parties using the ROW, or the necessity of removal in the future. If the Railroad determines the cable to be a nuisance or impairment at a future date, the FIBOCO will be required to remove the cable at the FIBOCO's expense.
- 3.10.34 Any abandoned core bored backwalls will require repairs to fill the bore with a suitable grout. If brackets must be removed from a bridge, do not torch cut bolts. After removing the bracket, insert a bolt in the open hole and paint with galvanized paint. If the bridge is concrete, cut the bolt flush with the concrete surface. Touch-up any scratched galvanized bridge surfaces, including bracket attachments, with galvanized paint.
- 3.10.35 Re-grade and clean construction sites to as good as, or better than, the condition they were before the project began. This may include replacing any vegetation by sodding, seeding disturbed areas with indigenous grass species, fertilizing and mulching. Perform clean-up and restoration as the project progresses. Do not wait until the end of the entire installation.
- 3.10.36 Immediately repair or replace any disturbed signs, poles, fencing and soil conditions to equal or better condition. Repair and/or monitor fences used to contain livestock. Ensure that livestock are not released onto the ROW. Protect against erosion in disturbed areas that are subject to erosion. Use temporary erosion control as dictated by local conditions, such as rock, riprap, wash checks, hay or straw cover, or other material that is approved by the Railroad's Fiber Optic Engineer and does not interfere with Railroad operations, by applicable environmental regulations.
- 3.10.37 Do not operate heavy equipment on Railroad's paved roads located on the ROW without prior approval of the CC. Use a protective covering over paved

roads when crossing them with heavy equipment. Coordinate such moves with the CC

- 3.10.38 When installing facilities on top of cuts, do not operate equipment or install cable within 5 feet (1.52 meters) of the top of the slope. This protects a five-foot (1.52 meters) buffer zone where rubber tired and tracked equipment is not allowed to drive on the top soil. (Refer to Exhibit K – Installation on Top of Cut)
- 3.10.39 Comply with all applicable federal, state, and local environmental laws and regulations. (Please refer to current edition of Common Ground Alliance Best Practices)
- 3.10.40 Where Public Utilities Commission requirements meet or exceed the requirements of the Railroad, those requirements will apply. This would include but not be limited to, safety, clearances and walkways. (Refer to Exhibits L & M – Standard For Minimum Clearances)
- 3.10.41 When an undesignated or otherwise unknown underground facility is discovered within a work area, report such discovery to the CC. If the discovery is made during the locating phase of the work, contact the CC to determine if the original design will be impacted. If damaged during excavation, cease operation, safely secure the area, contact the CC and the Railroad RMCC at 1-888-877-7267 and be governed by the authorized Railroad representative. Document the location on the As-Built.
- 3.10.42 Locating and marking is required before excavation can begin. All utilities, active and inactive, are to be located and marked. The American Public Works Association (APWA) uniform color code follows:

White	Proposed Excavation
Yellow	Gas, Oil, Steam, Petroleum or Gaseous Materials
Red	Electric Power Lines, Cables, Conduit and Lighting Cables
Orange	Communication, Alarm or Signal Lines, Cables or Conduit
Green	Sewer and Drain Lines
Blue	Potable Water
Pink	Temporary Survey Markings
Purple	Reclaimed Water, Irrigation and Slurry Lines

(Please refer to current edition of Common Ground Alliance Best Practices)

- 3.10.43 Marker signs should be placed near the outer edge of the ROW. This is not always possible since, for example, in areas where the ROW is extremely wide, adjacent landowners, farmers or others may be utilizing a portion of the ROW. As an example, if the ROW edge is 200 feet (60.96 meters) from the center line of the track, and the farmer's fence is 150 feet (45.72 meters) from the center line of the track, placement of the marker post at the ROW edge

would result in a marker post in the middle of a field or pasture. In this case, a suggestion would be to place the marker post near the farmer's fence, or the established physical boundary.

- a) Marker signs should not be placed directly under utility poles. This practice results in an impaling danger to those climbing the poles for utility maintenance.
- b) Marker signs are intended to visually alert potential excavators to the presence of buried fiber optic facilities and as a means to instruct potential excavator(s) to call before they dig. Do not cluster marker signs. It is suggested to place only one marker post, representing the FIBOCO, at intervals that do not hinder Railroad operation within the RO

3.10.44 Examples leading to marker post placement misunderstandings along the ROW are provided below to help identify and provide workable solutions to this portion of the construction project.

- a) General statements that suggest placement of markers signs to be within one foot (or other specified distances) off of the fiber optic running line is not a good recommendation.
- b) Marker signs placed consistently at one foot off of the fiber optic cable running line will set precedence, which others will make note of. Others will assume that this is always the case. This is not always the case since circumstances will not always allow this. Also, when a post is knocked over, people tend to reset the post, which may or may not end up in the original location.
- c) If marker signs are placed within close proximity to the fiber optic cable running line and are struck by a vehicle, they could be driven through the innerduct and possibly the fiber cable.
- d) Fiber optic cable running lines are occasionally in a maintenance road. Marker signs cannot be placed in the maintenance road, since they would effectively get knocked down and interfere with other operations.
- e) Fiber optic cable running lines are occasionally in a ditch or waterway. Marker signs cannot be placed in ditch or waterway, since they would interfere with maintenance and/or wash away.
- f) Fiber optic cable running lines may have several running line changes in a given segment of the ROW. However, marker signs should not be placed in this manner. Marker signs should

be kept as straight as possible, in consideration of maintenance operations of both the Railroad and of the FIBOCO

- 3.10.45 Above all else, please exercise common sense and the safest course of action in the determination of marker post placement.
- 3.10.46 If previously placed signs interfere with drainage, ROW maintenance and/or maintenance roads, or create a safety hazard (such as an impaling hazard), such signs shall be moved.
- 3.10.47 Marker signs along all routes are to be maintained by the FIBOCO. Marker Signs which are leaning must be repositioned. Marker signs are to be upright and plumb and of proper standard height. Damaged or bent marker signs should be replaced or removed. The appearance of Railroad property must be maintained.
- 3.10.48 When more than one FIBOCO shares the same general location, the placement of marker signs should utilize the same post whenever practicable.
- 3.10.49 Ensure that proofing of the duct system allows fiber installation with minimal excavation. Additional excavation requires prior approval from the CC.
- 3.10.50 When proofing, the exit end of the duct system is considered a Red Zone and safety precautions must be taken to protect this area.
- 3.10.51 All construction must follow the requirements of Railroad and all appropriate state and national electric codes. Where conflicts exist between these guidelines and those of the state and/or national codes and regulations, the stricter interpretation shall take precedence.

3.11 GENERAL FIRE PREVENTION SAFETY and HOT WORK PROCESSES

- 3.11.1 All workers must take every precaution to prevent loss and damage by fire. FIBOCO is responsible for ensuring that a current fire protection plan is in place and conforms to applicable laws and regulations.
- 3.11.2 Do not place gasoline or other combustible materials, including oxygen and acetylene, in a bus or truck compartment occupied by the driver or other persons. Do not transport gasoline or other combustibles in an automobile trunk, except in an emergency and then only in an approved container secured against movement.

- 3.11.3 Use caution when parking a vehicle on the ROW so that heat from the exhaust system does not ignite the surrounding vegetation.
- 3.11.4 Any work activity that produces sparks or open flame is considered to be Hot Work. As first consideration all Hot Work shall be performed off of Railroad property, if possible. This work includes, but is not limited to, any activity that creates live flame, molten slag or, sparks. Hot Work includes metal cutting, welding, grinding, and using a cut-off saw for metal or dry concrete. The use of abrasive wheels to cut or grind and any type of welding or using a torch shall be considered Hot Work. Open warming fires are not allowed in any manner, shape or form.
- 3.11.5 If removal of the planned Hot Work activity from Railroad property is not possible FIBOCO is required to fill out the Hot Work Checklist (Refer to Exhibit Q – Hot Work Checklist)
- 3.11.6 Prior to any Hot Work a job briefing must be conducted to discuss the following:
- a) Ensure the CC has been advised of all proposed Hot Work activities.
 - b) Preparation of the Hot Work Checklist by the contractor and discussion of roles and responsibilities including assignment of the Fire Watch person.
 - c) Remove all combustible material within 50 feet of the Hot Work area.
 - d) Review of the risk factors identified in the fire risk assessment and the application of the preventive measures required.
 - e) Fire prevention plan detailed in Railroad Emergency Response Form to be used in case of fire. (Refer to Exhibit T – Railroad Emergency Response Form)
 - f) Review of the evacuation routes from the work site.
 - g) Review of the applicable emergency response plan.
- 3.11.7 Every effort should be made to extinguish a fire without endangering the safety of workers. Report promptly to RMCC any fire seen on or near the ROW, unless the fire is being controlled.
- 3.11.8 Fires that get out of control must be reported to local fire/emergency personnel and RMCC (888-877-7267). The area must be evacuated using the route detailed in the job briefing. Others in the immediate area also must be alerted.

3.12 WORK EQUIPMENT

- 3.12.1 **NEVER** move equipment across railroad bridges or through tunnels.
- 3.12.2 Passengers in moving vehicles are required to be seated on actual seats in enclosed vehicles with seat belts fastened. Do not project body parts beyond the sides or rear of the vehicle. Do not transport passengers in truck beds. These requirements include transporting people on heavy equipment.
- 3.12.3 Use of equipment such as front loaders and backhoes to raise or lower people is strictly forbidden.
- 3.12.4 Escort outside company personnel (such as concrete truck operators) on and off the ROW. It is the responsibility of the FIBOCO to arrange such escorts.
- 3.12.5 Use of any equipment that is outside 25 feet (7.62 meters) from center line of the nearest track, that has the capability to reach within 25 feet (7.62 meters) [the Red Zone – Area with 4 feet of tracks] of the center line of the nearest track, must be coordinated with the CC.

3.13 WORKING NEAR POWER LINES

- 3.13.1 When performing work near electrical power lines, the clearance shown below must be maintained between personnel, their tools and equipment, and the nearest power line.

Operating Voltage Distance in Feet:

- 0-5,000 – 4 Feet
- 5,000-15,500 – 6 Feet
- 15,500-25,000 – 7-1/2 Feet
- 25,000-35,000 – 9 Feet
- 35,000-50,000 – 12 Feet

Note: For voltages over 50,000 volts, add 1.2 inch for each KV (1,000 volts).

- 3.13.2 Measuring overhead clearance - A qualified person is required to measure overhead clearances using the proper instruments. Do not use steel or cloth tapes, ropes or strings to measure overhead clearance.
- 3.13.3 Booms near power lines - Do not operate booms over power lines at any time. Do not operate them under power lines unless proper clearance is maintained. If proper clearance cannot be maintained, shut off the power and ground power lines before performing work.
- 3.13.4 Proper clearances - If booms must be operated near energized lines, the following clearances must be maintained:
- a) Lines rated 50 KV (50,000 Volts) or less, minimum clearance between the lines and any part of the crane or load must be 10 feet.
 - b) Lines rated over 50 KV (50,000 Volts) and less than 170 KV (170,000 Volts), minimum clearance between the lines and any part of the crane or load must be 15 feet.
 - c) Lines rated over 170 KV (170,000 Volts), minimum clearance between the lines and any part of the crane or load must be 15 feet plus 1/2 inch per KV in excess of 170 KV (170,000 Volts).
 - d) When in transit, with no load and boom lowered, the equipment clearance must be a minimum of 8 feet for voltages less than 15 KV and 10 feet for voltages 15 to 50 KV.
 - e) For voltages 50 to 470 KV, the clearance must be increased 1/2 inch per KV in excess of 50 KV.
 - f) A groundman must be designated to observe equipment clearance and give timely warning for all operations when it is difficult for the operator to observe clearance.

3.14 TRENCHES AND EXCAVATIONS

Prior to the start of any trenching or excavating a "Competent Person" as defined by the OSHA guidelines must be designated to ensure compliance with the proper trenching standards.

- 3.14.1 Keep bore pits and other excavations to the minimum size necessary.
- 3.14.2 Use shoring conforming to the most restrictive of state, OSHA, or Railroad recommendations in all excavations where required. Refer to OSHA standards and the joint UP and BNSF "Guidelines for Temporary Shoring", (Refer to Exhibit I – General Shoring Requirements).

- 3.14.3 When excavation work will be within the ROW, shoring plans and other required material must be submitted to the Railroad's Fiber Optic Engineer for approval prior to any construction.
- 3.14.4 Avoid the need for workers to be in trenches whenever possible. For example, when trenching in a conduit system, the pipe to be placed should be assembled above the trench and lowered down into the trench. When workers are required to go into an excavation, shoring and confined space requirements will govern. (Refer to Section 3.14.2 above.)
- 3.14.5 Backfill, cover or fence all excavations when unattended. The CC will approve the protection method and the type of fencing material. Set fencing back at least 3 feet (91 centimeters) from the edges of the excavation. Set fence posts securely in the ground and ensure the fencing is securely tied to posts with zip ties or some other tie wrap product.
- 3.14.6 Compact all permanent backfill in excavations and trenches to 95% maximum dry density as defined in ASTM Standard D698. Use clean, suitable backfill material, placed in six-inch lifts. (Temporary backfill may not need to meet this requirement subject to approval of Railroad's Fiber Optic Engineer.)
- 3.14.7 Any entry or use of confined space will require compliance to OSHA Standards.
- 3.14.8 Maintain escape routes, using foot walks or ladders meeting appropriate specifications, in all excavations to allow safe access to the excavators.
- 3.14.9 **NEVER** leave excavations, including trenches, potholes for locating utilities and other obstacles unattended or unprotected. Fence, fill or guard each site prior to leaving. (Refer to Section 3.10 – Construction)
- 3.14.10 Monitor shored trenches and excavations continuously during work for signs of instability and failure. (Refer to Exhibit R – Trench Safety Inspection Checklist)
- 3.14.11 Always have at least two employees on site during work in an excavation.
- 3.14.12 **NEVER** work closer than 4 feet (1.22 meters) from the nearest rail without following **ON TRACK SAFETY** procedures. Although you must have a flagger with you in these circumstances you must also comply with **ON TRACK SAFETY** procedures.
- 3.14.13 **DO NOT TAKE SHORT CUTS!!!**

3.15 TRENCHLESS INSTALLATION OF FIBER SYSTEMS

3.15.1 Submit plans for all under-track bores on the ROW to the Railroad's Fiber Optic Engineer for approval. These must be engineered plans and not just generic typical details. Include the following on the plans:

- a) Boring methods and equipment;
- b) Depth(s) of the fiber system;
- c) Locations of bore pits relative to center line of the nearest track;
- d) Casing specifications.

Note: All bores under tracks are subject to track monitoring. Include a track monitoring plan with your submittal. Refer to Union Pacific Railroad Guidelines for Track & Ground Monitoring.

3.15.2 An extensive geotechnical analysis may be required to verify that Railroad tracks will not be affected by the proposed bore. It is the responsibility of the FIBOCO or its contractor to provide such an analysis at the Railroad's request.

3.15.3 All bores are subject to federal, state and/or local regulations.

3.15.4 The location of the bore pit must not conflict with Railroad facilities. This may require designing a longer than normal bore when crossing roads to avoid signal facilities.

3.15.5 Ultimate approval and direction of the boring process rests with the CC. The CC has the authority to delay the operation or establish additional requirements based on site characteristics.

3.15.6 Under-track bores are subject to the following requirements:

- a) Keep track bores under mainline tracks to a minimum.
- b) Design track bores to be greater than 150 feet (45.72 meters) from the nearest bridge, culvert, road crossing, track switch, building or other major structure. (Refer to Exhibit H – Standard Turnout)
- c) Design bore pits to be a minimum of 30 feet (9.14 meters) from the center line of the nearest track when measured at right angles to the track. In addition, never locate bore pits in the slope of a cut or fill section of the roadbed. Keep the bore pit size to a minimum. Refer to Section 3. 14 - Trenches and Excavations (Refer to Exhibit E – Typical Railroad Bore & Pit Location)
- d) All under track bores are to be at 90 degrees. When using a directional bore, a 60-degree angle or less may be used, at the discretion of the CC, if

justified due to ROW or terrain constraints. (Refer to Exhibit E – Typical Railroad Bore & Pit Location)

- e) Pull back methods may use mandrels up to one and one-half times the diameter of the casing, up to a casing diameter of 12 inches (304.8 millimeters).
- f) Any parallel-to-track bore that is made in either a cut bank or fill section will be located a minimum of 60 inches (1.52 meters) below the toe of the ballast section or natural ground, or 84 inches (2.13 meters) below the base of rail, whichever is lower. (Refer to Exhibit J – Fill Installation – Directional Bore)
- g) Casing pipe is required on all under track bores involving multiple duct systems, regardless of depth.
- h) The bore plan should show the bore path profile. A bore plan or logbook must be kept with the boring equipment and provided to the CC or other Railroad employee when requested.
- i) An under-track bore will not simultaneously cross the track(s) and an at-grade road crossing.
- j) The machine operator follows all current OSHA regulations, including the use of grounding mats and other safety measures.
- k) The machine operator has control over the direction of the boring tool.
- l) Work Zones of 10 feet (3.05 meters) must be established around all existing facilities not positively located. Voice communication must be maintained between machine operator, locator, and anyone else occupying the Red Zone of the drilling operation.
- m) All tools and equipment must be present at the job site prior to the start of the drilling operation.
- n) The bore crew must have, in their possession, a copy of the permit authorizing the company to perform work on the ROW, and a copy of the Railroad approved drawings and specifications for the bore work location. Bore profiles must be approved by the CC, prior to the start of all bores.
- o) When possible, mark the proposed running line every 5 feet (1.52 meters) to 10 feet (3.05 meters), using a longitudinal line, prior to the bore operation. Mark the actual bore head location with a paint spot at the end of each stem push. Only white paint is approved for this use.
- p) The bore is not allowed to deviate more than 6 inches (15 centimeters) from the proposed marked running line and the ends of the bore must be at the designated depth.
- q) Non-standard bores, misdirected bores, or other unsuccessful bores that have been approved to be abandoned by the CC are to be filled with non-shrinking grout (or equivalent) including all voids. Documentation of the failed bore must be provided to the CC.
- r) If a bore is unsuccessful, future attempts are made only with the approval of the CC. Additional attempts, with CC approval, will be re-drilled through the abandoned bore, including abandoned conduits, prior to obtaining CC authorization to relocate the bore.

- s) The bore operation will be stopped if any damage occurs to the Railroad subgrade or track structure and it shall remain inactive until corrective measures are taken at the direction of the CC. The FIBOCO is liable for any damage done to the ROW, structures, or train operations.
- t) Auger heads are not allowed more than 6 inches (152.4 millimeters) ahead of the casing being inserted.
- u) Any void greater than 2 inches (50.8 millimeters) between the conduit and the casing will require cobblestone, a fabric filter, or the ends to be closed off at the discretion of the CC.
- v) When boring near creeks and streams, silt fences will be properly installed to prevent disturbed soil from flowing into the waterways and remain in place after the bore has been completed.
- w) Crews must have access to shoring in the event of a utility cut.
- x) The bore shall allow the path to be at a zero slope for a minimum of 30 feet (9.14 meters) from the center line of the track, 2 feet (.61 meters) from the toe of the slope and 3 feet (.91 meters) beyond the ditch, whichever is greater.

3.15.7 Mini-Directional and Directional bores/drilling are permissible.

Directional bores will be considered for under-track and parallel-to-track bores on a case-by-case basis, subject to these additional constraints:

- a) Under-track bores are installed a minimum depth of 15 (4.57 meters) below the base of rail, or 60 inches (1.52 meters) below the natural ground line, whichever is greater. (Refer to Exhibit O – Typical Railroad Directional Bore Depth)
- b) All under track directional bores **MUST** be installed with a means of locating the facility in the future.
- c) Slurry use is kept at a minimum and only used for head lubrication and/or spoils return. Calculate anticipated slurry use and monitor slurry use during the bore operation to determine slurry loss into the surrounding soil. Bentonite slurry is required, and pressures must be controlled for the type of soil being bored. All voids created during the bore operation must be grouted. Using slurry other than bentonite requires CC approval and must not leave voids or contaminate the soil.
- d) Slurry must be contained during the bore operation and must be removed prior to backfilling with dry dirt.
- e) The maximum size of the installed product is 12 inches (304.8 millimeters).
- f) Bentonite slurry should be used to seal the hole with a minimum of 95% return.
- g) Bore stems and cutting heads may have to be left in the ground if they cannot be retrieved through the bore hole. Open excavation to retrieve the parts may not be possible.
- h) If an under-track bore is at a depth of 15 feet (4.57 meters) below base of rail or more, a single duct system can be pulled back without a casing

pipe. The pullback hole must be as small as possible and is not to exceed one- and one-half times the diameter of the finished duct. Exceptions must be approved by the CC.

- i) The design of the bore shall allow the path to be at a zero slope for a minimum of 30 feet (9.14 meters) from the center line of the track, 2 feet (61 centimeters) from the toe of slope and 3 feet (91 centimeters) beyond the ditch, whichever is greater.
- j) The bore path of a parallel bore shall be at a zero slope for a minimum of the width of the facility causing the bore. Facilities shall include, but are not limited to, roads, culverts, ditches, streams, rivers, other utilities and tracks. The bore shall be extended, when practical, to avoid conflict with signal upgrades.
- k) A bore profile for the proposed bore must be included with the design plans, along with the entry angle.
- l) The drilling and/or reaming operation must utilize a locating system, such as a sonde (radio transmitter/beacon), in all forward and reverse movements.
- m) The entry angle must not exceed a 1 to 10 slope and must comply with equipment manufacture specifications.
- n) Pull back methods use mandrels up to one- and one-half times the diameter of the casing, up to a casing diameter of 12 inches (304.8 millimeters).
- o) Follow recommended machine mixing rates when adding bentonite to the drilling fluid.
- p) Be sure any HDPE duct still on the reel is secured, when cutting, to prevent movement.
- q) Any annular space must be properly grouted.

3.15.8 **Dry Bores:** Generally accepted dry installation methods for under-track or parallel-to-track bores include:

- a) Jacking the casing.
- b) Dry auger boring.
- c) Simple rod punching with pull back of casing.
- d) Directional boring without use of any liquid including control and lubrication of the cutting head.

3.15.9 When using a dry bore method, locate the fiber system a minimum of 60 inches (1.52 meters) below the base of rail or natural ground, whichever is greatest. Encase in galvanized steel pipe or black iron pipe [Specified Minimum Yield Strength of 35,000 psi (241,318 kPa) or above] all fiber system lines under tracks in a single casing. Extend the casing a minimum of 30 feet (9.14 meters) from center line of the track, measured perpendicular to the track, or longer, to stay out of cuts and/or fills. The casing shall be

extended a minimum of 2 feet (61 centimeters) beyond the toe of slope or 3 feet (.91 meters) beyond the ditch.

- 3.15.10 In some cases plastic pipe may be used as a casing instead of steel. Design of plastic casing will have to conform to the design methods in the AREMA Manual Chapter 1, Section 4, Culverts.
- 3.15.11 **Wet Bores (Jetting):** Generally, wet bores are not allowed for installing fiber systems on the ROW. Wet bores, or jetting, as used in this context refer to the use of liquids to displace soil.
- 3.15.12 **Other Bore Methods:** Generally, other methods of boring will be considered on a case-by-case basis. Special conditions such as rock drilling that require the use of high-pressure air or water are subject to all the conditions of this Section and will be evaluated as they occur. Blasting is not allowed.

3.16 HOUSEKEEPING

- 3.16.1 At the end of the day:
 - a) Secure all equipment.
 - b) Secure all open excavations.
 - c) Clean up work sites and ROW. Remove trash from the property or arrange for proper disposal.
 - d) Restore all disturbed ditches and culverts to water-carrying capability. This may, with Railroad approval, include culverts found during construction not previously identified or functioning.
- 3.16.2 Place all materials and equipment not in use at the outer limits of the ROW. Make sure all material and equipment is secured and safe. Do not place materials or equipment:
 - a) Closer than 25 feet (7.62 meters) from center line of nearest track, or within 500 feet (152.40 meters) of a road crossing.
 - b) On Railroad access roads.
 - c) Where it might cause injury.
 - d) Where it might cause environmental damage.
 - e) Where it might interfere with Railroad operations.
- 3.16.3 Do not place air hoses, water lines, electrical cords, etc. over or under rails without specific permission from the CC

- 3.16.4 Combustibles must be stored off of the ROW. Do not leave containers, empty or full, unattended on the ROW.
- 3.16.5 Do not obstruct sight distances at grade crossings with materials, equipment or personal vehicles. A minimum distance of 500 feet (152.4 meters) from road crossings must be maintained for stored materials and equipment.

3.17 BRIDGES, TUNNELS AND ABOVE GROUND INSTALLATIONS

- 3.17.1 A Railroad flagger is required during any work on bridges and tunnels. (Refer to Section 3.5 - Railroad Flagging/Protection.
- 3.17.2 Fall protection is required for work performed on all bridges and above ground installations. When working on bridges the most restrictive of either FRA Bridge Worker Safety Regulations (49 CFR Part 214) or the Railroad's Chief Engineer Instruction #122.0 will apply. Work on all other bridges and structures on the ROW is governed by the most restrictive of OSHA (29 CFR Parts 1910 and 1926), the Railroad's Chief Engineer Instruction #133.0, or state regulations.
- 3.17.3 Every effort must be made through job briefings, risk assessments and project planning to prevent falls. A Fall Arrest or Retrieval system should be considered in a rescue plan, but are not limited to the following:
 - a) Height of bridge
 - b) Surrounding terrain
 - c) Whether the bridge is over water
 - d) Whether the bridge is over another railroad track or roadway
 - e) Availability of professional rescue personnel
 - f) Number of employees at the job site
 - g) Retrieval equipment available at the job site
 - h) First aid equipment at the job site
 - i) Individual responsibilities
 - j) Consider all rescue options to minimize suspension/rescue time
- 3.17.4 Contractors performing work on bridges, tunnels and above ground facilities on or over Railroad property must submit written documentation certifying their employees have received proper training in fall protection, prior to engaging in work on Railroad property. The contractor must further satisfy the CC or his representative that proper equipment and compliance with these specifications will be adhered to on the job site.
- 3.17.5 Crossing a bridge or entering a tunnel is strictly prohibited without a Railroad representative (Refer to Section 3.18.1). Use the foot-walk when crossing

bridges or entering tunnels and always watch for trains. However, if no foot-walk is available, walk between the rails, with all appropriate caution.

- 3.17.6 Place materials and equipment in a location approved by the CC and plan for quick evacuation when so advised by the Railroad flagger or bridge operator.
- 3.17.7 No work is allowed on or around bridges or tunnels when trains approach or pass.
- 3.17.8 Obtain daily permission from the CC to climb the Railroad's poles to hang the fiber system. Ensure all power lines on the poles have been de-energized. Check the poles for structural integrity before climbing. Use climbing equipment conforming to OSHA regulations.
- 3.17.9 Any installation crossing the Railroad track, must comply with these specifications. In addition, where federal, state, local, and/or public utilities commission laws and regulations meet or exceed the requirements of the Railroad, those requirements will apply. (Refer to Exhibits L & M – Standards For Minimum Clearances)

3.18 WEATHER

- 3.18.1 Keep all employees informed of current weather conditions.
- 3.18.2 Stay alert for possible high water conditions.
- 3.18.3 During severe weather conditions:
 - a) Be prepared to take cover in the event of a tornado.
 - b) DO NOT work while lightning is occurring.
- 3.18.4 If storm conditions arise unexpectedly, ensure equipment is clear of tracks and secured before seeking cover.
- 3.18.5 Stay away from Railroad tracks when visibility is poor, such as during fog or blizzard conditions.

3.19 REPEATER STATIONS (REGENS)

- 3.19.1 The placement of regens or other structures on the ROW requires a Railroad Real Estate department lease, as well as approval by the Railroad Fiber Optic Engineer.
- 3.19.2 Regen design drawings must include the information as detailed in Section 3.8 Drawings, as well as the following:
 - a) A plan view clearly outlining the occupied area or “footprint” of the site, including, but not limited to building size and access, fenced perimeter, exclusive use access roads, parking areas and the running line.
 - b) Profile views detailing soil removal and the limits of all cuts and/or fills, required to construct the site, conforming to environmental requirements.
 - c) Cross-sections showing how site drainage is handled.
 - d) Indication of all details concerning the site, such as concrete pad depth, distance from center line of nearest track, all appurtenances, and distance from all road crossings.
- 3.19.3 Include with the power supply detail the following: voltages, distances relative to the mainline and other structures, overhead clearances and below ground dimensions.
- 3.19.4 Locate regens a safe distance from the nearest grade crossing. The governing minimum distance is the most stringent of either: 1) Local, state, or AASHTO clear sight distance requirements for grade crossings, or 2) 500 feet (152.4 meters). These requirements could vary due to train and vehicle speeds at the crossings. (Refer to Exhibit F – Regen Location)
- 3.19.5 Do not locate regens under signal, communication, or power lines.
- 3.19.6 Locate regens a minimum of 50 feet (15.24 meters) from center line of the nearest track to the nearest element of the regen facility and avoid placement adjacent to track curves. (Refer to Exhibit F – Regen Location)
- 3.19.7 Do not place regens where they may obstruct train signals or interfere with Railroad operations.
- 3.19.8 Regens may have to be located on private property to meet the requirements of this section.

4 DIG SAFELY – LOCATE ACCURATELY

- ❑ For planned work create a Railroad issued ticket request at www.up.com/cbud.
- ❑ For emergencies (fiber cuts or derailments) call the Union Pacific Call Before You Dig Center at 1-800-336-9193
- ❑ Call the state one-call or “811”
- ❑ Wait for the site to be marked
- ❑ Respect all markings
- ❑ Dig with care

**Locate Accurately
Dig Safely.®**

Underground Safety and Facility Damage Prevention
“A Shared Responsibility”



**Know what's below.
Call before you dig.**

5 DOCUMENTATION (AS BUILT DRAWINGS)

5.1 DESIGNER REQUIREMENTS

- 5.1.1 Ensure the designer of your fiber system gets a copy of these requirements as early as possible to avoid unnecessary delays. It is the intent that the information shown on the project construction drawings will easily convert to As-Built drawings by incorporating the changes made during construction.
- 5.1.2 Construction drawings that do not have the proper Railroad engineering stationing ties result in unacceptable As-Built drawings. If for any reason, construction plans are approved without the proper ties, it is the FIBOCO's responsibility to provide them prior to As-Built drawing approval. (Refer to Exhibit B - Methodology For Equating Fiber Optic Cable Locations To Railroad Track)
- 5.1.3 All of the dimensions in this manual have been given in English units with the metric unit equivalents in parentheses. However, all drawings submitted for Railroad approval need to have dimensions given in English units only. All As-Built drawing will be submitted at a scale of 1" = 100' (2.54 cm = 30.48 meters). An exception can be made for electronic media. Contact the Railroad Fiber Optic Engineer.
- 5.1.4 Include original drawing dates and revision dates on all revised drawings.
- 5.1.5 Include the following information on all construction plans and final As-Built drawings:
 - a) All drawings need to include GPS coordinates and format.
 - b) Alignment of the fiber system with Railroad engineering stationing at each running line change or Point of Intersection (PI) including hand holes, signs, and markers.
 - c) Depth of the fiber system, shown at each deviation of one foot (30 centimeters) or more.
 - d) Bridges (the Railroad engineering stationing shown is measured from inside the backwall of a bridge). (Refer to Exhibit C – Bridge Definition)
 - e) Bridge attachments and their details.
 - f) Culverts.
 - g) Signals, signal houses, and other signal facilities.

- h)** All grade crossings, overhead viaducts, and underpasses, including name of the street (public or private) and Railroad mile marker designation.
- i)** All utility crossings (both underground and overhead), and all parallel utilities.
- j)** Rivers, fences, and pole lines.
- k)** ROW limits.
- l)** Railroad station names and mile markers.
- m)** All mainline switches and secondary tracks.
- n)** Number of fibers (fiber count) and number of ducts.

5.1.6 Include a separate detailed drawing for each regen station. Show all details of the site, referenced to the mainline track, such as:

- a)** Building size and distance building is from all road crossings.
- b)** Distance the regen building is from center line of all adjacent tracks.
- c)** Power supply required for the regen building, including locations relative to the mainline, voltages, above and below ground dimensions.
- d)** Building access.
- e)** Any other facility pertinent to the project.
- f)** Location of fencing around the regen site, complete with dimensions.

5.1.7 Include the following additional information on construction drawings submitted to the Railroad:

- a)** General notes along with the symbols and their meanings.
- b)** A sheet showing all the special details.
- c)** Small scale maps showing the overall fiber system route.
- d)** Schematic showing regen sites.
- e)** Sheet showing various methods of erosion control.
- f)** Sheet showing details for backhoe trenching below a ditch, trench below a stream, direct burial for a ditch or creek crossing (plan and profile view).
- g)** Sheet showing detail for placement of conduit in rock, including provisions for protecting Railroad ballast where it may be fouled by rock sawing operations.

5.1.8 Show all measurements of each of the above from and at right angles to the center line of the nearest mainline track. Show on the drawing the distance to the next facility as measured along the center line of the main track.

- 5.1.9 Note: Mile markers found in the field are representative of actual Mile Posts found on the Railroad's valuation maps. These are intended to provide general locations of facilities for location by Railroad personnel. These mile markers are not accurately located on our maps and should not be used to establish Railroad stationing. Show them on your drawings for reference only.
- 5.1.10 Submit As-Builts to:
Engineering – As-Builts
Union Pacific Railroad Company
Mail Stop 0640
1400 Douglas Street
Omaha, NE 68179
(402) 544-7425 or (402) 544 3582
- 5.1.11 Submit As-Builts no later than 90 days after the completion of the installation of the fiber system on the ROW. The project is not complete until this is done.

6 MAINTENANCE

6.1 EMERGENCY MAINTENANCE

- 6.1.1 In the event that emergency work is required, the following procedures apply:
- a)** Notify the RMCC immediately at 1-888-UPRR-COP (1-888-877-7267).
 - b)** Call the CC for emergency engineering approval. Railroad will determine inspector/flagger needs based on site conditions. (Refer to Section 3.5 – Railroad Flagging/Protection)
 - c)** Perform emergency work only when appropriate flagging/inspection personnel are on site.
 - d)** Following the completion of emergency repairs to restore the fiber system to service, permanent restoration of the fiber system falls under the conditions of the following section.
 - e)** Prior Railroad notification of any excavation involving ROW must be provided.
 - f)** Any Railroad designated non-entry point due to dangerous or hazardous conditions must be strictly adhered to.

6.2 REGULAR MAINTENANCE

- 6.2.1 Obtain a Railroad issued dig ticket at www.up.com/cbud. This ticket must be issued no less than 48 hours before excavation is scheduled to begin. This ticket will facilitate the performance of your work by ensuring that Railroad personnel and other communication companies affected by your work receive notification of your work.
- 6.2.2 The methods and procedures of all maintenance and repair work are subject to the consent and approval of the Railroad Fiber Optic Engineer. Submit to the Railroad Fiber Optic Engineer for approval plans for any work not previously detailed in the Approved Plans. Include (as applicable) drawings showing the plan, elevation, details, Railroad engineering stationing and methods of the proposed construction, installation, maintenance, repair, replacement, or other work.
- 6.2.3 Coordinate the scheduled start dates of all work with the CC. Maintenance and repair schedules are subject to the availability of Railroad CC, flaggers, signal maintainers, and other Railroad personnel necessary to ensure that the work is performed safely and without disruption to Railroad operations.
- 6.2.4 FIBOCO crew locations and the number of crews may be restricted depending on Railroad flagger availability, job site access and adequate radio communications.
- 6.2.5 Ensure that all representatives and employees of the FIBOCO and its contractor have been safety trained by a representative of the Union Pacific Fiber Optic Group and display their annual "Safety Trained" stickers on their hard hats
- 6.2.6 Follow the construction guidelines in Section 3.10 - Construction for any repair or maintenance work involving alteration of the fiber system.
- 6.2.7 Never allow work to disrupt Railroad operations, including but not limited to, train operations, facilities maintenance, and communications.
- 6.2.8 Do not store or place equipment, supplies, materials, tools, or other items within 25 feet (7.62 meters) of the center line of nearest track unless the CC approves such placement.
- 6.2.9 Begin clean-up and restoration immediately upon completion of maintenance operations. Restore the ROW to as good as or better condition as prior to the maintenance being performed. This requirement includes any property encumbered by the fiber optic easement, whether or not the underlying rights reside with the Railroad, i.e. leased lines, commuter agencies, other rail lines.

- 6.2.10 To protect other utilities, prevent missed locates, and maintain current, meaningful location data, remove abandoned fiber optic cable system facilities. (Refer to Section 3.10.33)
- 6.2.11 If any component of the fiber system is not removed, maintain records of the location of such abandoned fiber system facilities. Abandoned facilities must be located and maintained unless removed from the Railroad property.
- 6.2.12 When maintenance requires additional facilities, such as hand holes, manholes, regens, conduits or any ROW disturbance, Railroad engineering approval is required per Section 2 – Engineering Process.
- 6.2.13 Notify the CC prior to setting up your maintenance route patrols. Make sure the CC is aware of any frequency or schedule changes, including emergency patrols. Be aware that weather conditions, increased train traffic, locks, security and access roads may affect your patrol.

7 DEFINITIONS

811: The national One-Call phone number.

Aerial Marker Sign: A large sign, typically in the shape of a "V" that can be observed from the air, used for aerial location and inspection of the fiber system.

Approved Plans: Plans submitted by a FIBOCO to the Railroad and approved by a Fiber Optic Engineer.

As-Built: A drawing, depicting the actual location of the fiber system in relation to the Railroad, having proper documentation for approval by the Railroad Fiber Optic Engineer.

Ballast: The rock that supports the track and ties. This rock is groomed to keep the track in place, drain water away from the track, and to distribute the weight of trains to surrounding soil. DO NOT DISTURB.

Branch line: A secondary route to the Railroad that, for safety reasons, should be treated as a primary line.

Bridge Attachment: A Railroad-approved method of affixing the fiber system to one of the Railroad's bridges.

Bridge Backwall: The topmost portion of an abutment above the elevation of the bridge bearing, functioning primarily as a retaining wall for the roadbed.

Bridge Bearing: The contact area and/or physical connection between bridge girders and bridge abutments or piers. (Refer to Exhibit C – Bridge Definition)

“Call Before You Dig” (CBUD): A Union Pacific 24-hour by 7-day communication center, available through the **1-800-336-9193** number, to assist in protecting, documenting and notifying callers of authorized fiber optic facilities installed within the ROW. The center is to be used by anyone proposing to dig on the ROW. **For planned work, it is best to request a Railroad issued dig ticket at www.up.com/cbud.**

Casing: A secondary, independent, rigid covering used to protect the fiber system and the roadbed when installed under the Railroad's tracks.

Center line of Track: An imaginary line, that runs down the center of the two rails of a track.

Common Ground: A study titled *Common Ground: Study of One-Call Systems and Damage Prevention Best Practices*, authorized by the Transportation Equity Act (TEA 21), Public Law 105-178 signed into law on June 9, 1998, through the United States Department of Transportation, Research and Special Programs Administration Office of Pipeline Safety and the One-Call Systems Study.

Competent Person (OSHA): A person who is capable of identifying existing and predictable hazards in the surroundings, or working conditions which are unsanitary, hazardous, or dangerous, and who has authorization to take prompt corrective measures to eliminate them. (29 CFR 1926.32(f). To be a "Competent Person", a person must have training in, and be knowledgeable about, soils analysis, the use of protective systems and the requirements of this standard.

Conduit: An independent tube or duct system used to house one or more fiber optic cables.

Confined Space: A space that is large enough and so configured that an individual can bodily enter and perform assigned work. The space has limited or restricted means

for entry or exit and is not designed for continuous individual occupancy. This would include but not limited to tanks, vessels, silos, storage bins, hoppers, vaults and pits.

Construction Coordinator (CC): A Union Pacific Railroad Company employee or representative of the Railroad who serves as the liaison between the FIBOCO and the Railroad.

Contractor: Any FIBOCO authorized worker, other than a Railroad employee, who is working on Railroad property as a FIBOCO representative or agent.

Cooper E-80: A loading specification as defined in the AREMA Manual for Railway Engineering.

Cut: A section of earth that has been excavated to allow construction of the Railroad's track where an embankment remains on one or both sides of the track.

Derailment: A potentially dangerous condition, whereby Railroad cars or engines leave the tracks.

Dig Ticket: Issued by Union Pacific's CBUD upon timely communication by an excavator/designer requesting its intent to excavate for any reason along Railroad Property.

Directional Bore: A method that controls the direction of boring and eliminates conventional bore pits allowing for a longer bore length than conventional methods.

Dispatcher: A Railroad employee responsible for authorizing all track use, including train movements and maintenance.

Drawings: A graphic representation of proposed fiber routes, detailed construction plans, or As-Builts.

Employee In Charge (EIC): The Railroad Employee on site who is responsible for providing positive train protection for employees or contractors working on or near the tracks.

Emergency Response Plan: Develop basic preparedness steps developed to handle the anticipated emergencies at your work site. Although Emergency Response plans are not meant to be all-inclusive, they should provide appropriate guidance on what to do in an emergency for the work being performed.

Encased: A term used to indicate that the fiber system has a secondary, independent, protective covering.

Engine: The vehicle used to pull Railroad cars. Typically, this refers to the locomotive, but can be any self-propelled vehicle.

Excavation: Any removal of earth to allow installation of the fiber system. Any excavation, no matter how large or small, requires a telephone call to Union Pacific's CBUD desk at **1-800-336-9193**, or online at **www.up.com/cbud**.

Fall Protection: A requirement by the FRA and Railroad, that ensures training and protection for work performed on any bridge structure that is at a height of 10 feet (3.05 meters) or more above water or ground, and/or while working at a height of 10 feet (3.05 meters) or more.

Fall Arrest (Retrieval) Plan: Arrangement of fall protection equipment in such a manner that it will arrest a fall in progress before a person reaches any surface or obstruction below and initiate the rescue of a fallen worker(s).

FIBOCO (Fiber Optic Company): The facility owner or company that enters into the agreement with the Railroad and has the ultimate responsibility for all aspects of

construction, maintenance and operation of the fiber system. This responsibility includes any contractor, employee, or consultant hired by that company.

Fiber Optic Database: Railroad’s electronic CBUD database.

Fiber Optic Engineer: Engineering representatives from Commercial Telecommunications Group as identified in Exhibit A

Fiber System: A telecommunications transmission system and its appurtenances.

Fill: A section of earth built up to support the Railroad's track structure.

Fire Prevention: Before beginning any Hot Work, completion of the Hot Work Checklist is required. (Refer to Section 3.11 – General Fire Protection Safety and Hot Work Procedures)

Flagger: A Railroad employee, working at the direction of the CC, who provides On Track Safety to prevent accidents and injuries to roadway workers..

Foul the Ballast: Anything that contaminates the ballast section of the roadbed and inhibits the ballast from supporting the track, draining water, or suppressing weed growth.

Foul the Track: Any obstruction that renders the track system unsafe for train passage.

Grout: A cementitious or epoxy substance used to repair concrete, fill holes in concrete, or to anchor bolts, rods, etc., in concrete. Grout must be approved by Railroad Representative prior to use.

HS-20: A loading specification as defined in the AASHTO Standard Specification for Highway Bridges.

Hot Work: Considered to be any work activity that produces sparks or open flame. This work includes, but is not limited to, using abrasive wheels to cut or grind, any type of welding and using a torch. (Refer to the Section 3.11– General Fire Protection Safety and Hot Work Procedures)

Hy-rail: A vehicle, typically driven on highways, that has specially manufactured attachments, that allows the vehicle to travel on Railroad tracks. They are viewed as trains, and only authorized Railroad personnel may operate them.

Industry Track: A secondary track designated to allow access to industries along the main track.

Innerduct: Flexible independent tubes inside a conduit.

Job Site: Any area where work is performed, where materials and equipment are stored, or which employees access during the fiber project.

Lateral: A connection or tee that exits the main backbone cable and exits the right of way.

Locate: The determination in the field of the depth and horizontal position of fiber optic systems or other underground utilities.

Mainline/Main Track: The primary track used by trains. Some of the routes have double, triple, and quadruple mainline tracks.

Marker signs: Signs placed by the FIBOCO indicate a fiber system is in the area, provide a 1-800 number for information regarding the system, and provide the FIBOCO's name.

Mile markers: Field indicators of approximate distance from a specific point on the Railroad system used for approximate locations of Railroad Facilities. They are not to be used for field surveys.

Mile Post: A theoretical breakdown of rail lines into mile-long segments.

On Track Safety: A set of safety procedures, developed and promulgated by the FRA, that must be complied with to work on or near Railroad property. Specific training and obedience to these procedures is a requirement of the FRA. Where Railroad processes and procedures are more stringent, those processes and procedures shall apply. Significant fines and the loss of your permission to work on the ROW can result from the violation of these procedures.

Point of Intersection: A point on a map or drawing indicating the location of a curve in the fiber system. The point is the vertex of an angle formed by the intersection of two sequential, non-parallel segments of the fiber system.

Railroad: Union Pacific Railroad Company and its Railroad affiliates and subsidiaries.

Railroad Car: Any vehicle that can move on the track structure and is not self-propelled.

Railroad Stationing: A standard linear survey stationing scheme adopted by Railroad (and others) and used on Railroad track maps. Used for locating physical features and structures on the ROW.

Remote Controlled Locomotives (RCL): A locomotive controlled remotely by a radio transmitter and receiver by a person not physically located at the controls within the confines of the locomotive cab.

Red Zone: The area within 4 feet of any track, or any physical position which places the person in a life-threatening situation. This includes working around derailments, highway crossings and equipment work zones.

Regen: An acronym for a regeneration facility. Typically, a building along the fiber system route housing equipment.

Regen Facility: The regen building and all of its appurtenances such as fences, signs, posts, or other physical features.

Right-of-Way (ROW): Land that the Railroad owns or owns an interest in that contains facilities for train operations and which is utilized in the performance of the fiber project.

RMCC (Response Management Communication Center): A Union Pacific 24-hour by 7-day communication center, staffed by the Railroad to handle any emergency situation, including but not limited to, an ability to stop trains and notify emergency personnel. The 1-888-UPRR COP (1-888-877-7267) number should be used to report any unsafe condition or emergency while on Railroad property.

Roadbed: The graded area beneath and on either side of the track structure that provides support and drainage of the track.

Running Line: Proposed or existing location of the fiber optic system.

Safety Training: A session conducted by a qualified Railroad representative at which Railroad processes, procedures and regulations are presented and discussed.

Safety Sticker: An emblem that indicates completion of Railroad Safety Training. The non-transferable "Safety Trained" emblem is to be placed on each individual's hard hat so it is visible when working on the ROW.

Shoring: Methods and materials used to prevent the collapse of the earthen walls of excavations.

Siding: A secondary track used for the passing of trains on single-track routes.

Signal: A Railroad facility used to provide for the safe movement of trains and protection at crossings. The facilities include gates, lights, wires, bungalows, and all ancillary devices supporting these operations.

Splice: A point in the fiber optic system running line where cables are fused together to create a continuous system.

Spur Track: A secondary track designed to allow access to industries along the main track.

Switch: A moveable track device that allows trains to transfer from one track to another, encompassing the distance from the point of switch to the point of frog. (Refer to Exhibit H – Standard Turnout)

Tracks: The rails, ties, and ballast that compose the traveling surface used by trains.

Track Structure: The rails, ties, ballast, and roadbed that compose the traveling surface used by trains.

Trains: One or more engines coupled together, with or without Railroad car(s) that use the Railroad's tracks.

Train Movement: Any motion of engines and/or Railroad car(s) over the Railroad's tracks.

Trench: A narrow section of earth removed to allow installation of the fiber system.

Valuation Map: A Railroad map depicting the Railroad's facilities and engineering stationing. Also referred to as a track map.

Wet Bores (Jetting): Are bores that use liquid to displace soil. (Refer to Section 3.15.10)

Yard: A collection of secondary tracks used to store equipment (Railroad car(s), engines, maintenance machines, etc.), assemble or disassemble trains, and/or conduct other Railroad operations.

8 ABBREVIATIONS

AASHTO: American Association of State Highway and Transportation Officials

ANSI: American National Standards Institute

AREMA: American Railway Engineering and Maintenance-of-Way Association

ASTM: American Society for Testing and Materials

BIP: Black Iron Pipe

Br: Bridge

CBUD: Call Before You Dig

CC: Construction Coordinator

CE: Chief Engineer

CG: Common Ground

CIP: Corrugated Iron Pipe

CL/Trk: Center Line of Track

CMP: Corrugated Metal Pipe

Conc: Concrete

C/L: Center Line

EIC: Employee In Charge

FIBOCO: An acronym for the fiber optic company

FRA: Federal Railroad Administration

F/L: Flow Line

GPS: Global Positioning Satellite. A system used for geo-locating physical features and structures on the earth's surface.

GSP: Galvanized Steel Pipe

HDPE: High Density Polyethylene Plastic

HH: Handhole

Lt: Left

MH: Manhole

MM: Mile marker

MP: Mile Post

MUV: Multi-Purpose Utility Vehicle

OSHA: Occupational Health & Safety Administration

PI: Point of Intersection

PVC: Polyvinyl Chloride Plastic

RCL: Remote Control Locomotive

Rt: Right

R/L: Running Line

RMCC: Response Management Communication Center

ROW: Railroad right-of-way

Xing: Crossing

9 APPENDIX

9.1 List of Exhibits:

- A) UNION PACIFIC RAILROAD SAFETY, ASSET UTILIZATION & FIBER OPTIC TECHNOLOGY GROUP LIST**
- B) UNION PACIFIC RAILROAD METHODOLOGY FOR EQUATING FIBER OPTIC CABLE LOCATIONS TO RAILROAD TRACK AND RIGHT-OF-WAY MAPS**
- B-1) STRAIGHT LINE DRAWING**
- C) BRIDGE DEFINITION**
- D) CABLE DEPTH AROUND CULVERTS AND DITCHES**
- E) TYPICAL RAILROAD BORE AND PIT LOCATION**
- F) REGEN LOCATION**
- G) CONVENTIONAL FILL INSTALLATION**
- H) STANDARD TURNOUT (TRACK SWITCH)**
- I) GENERAL SHORING REQUIREMENTS**
- J) DIRECTIONAL BORE FILL INSTALLATION**
- K) INSTALLATION ON TOP OF CUT**
- L) STANDARD FOR MINIMUM CLEARANCES**
- M) STANDARD FOR MINIMUM CLEARANCES (Continued)**
- N) ROCK TRENCH**
- O) TYPICAL RAILROAD DIRECTIONAL BORE DEPTH**
- P) HANDHOLE LOCATION**
- Q) HOT WORK CHECKLIST**
- R) TRENCH SAFETY INSPECTION CHECKLIST**
- S) DRAWING SUBMITTAL MINIMUM REQUIREMENTS**
- T) RAILROAD EMERGENCY RESPONSE FORM**

9.2 References:

Current Common Ground Alliance (CGA) Best Practices General Guide

**For additional information on the Common Ground Alliance, or learn how to become a member, visit the CGA Web Site At:
www.commongroundalliance.com**

Current American Railway Engineering and Maintenance-of-Way Association (AREMA) Manual For Railway Engineering

For Additional Information on AREMA and recommended practices for design, construction and maintenance of railway infrastructure, visit the AREMA Web Site at: www.arema.org

10 INDEX

Accidents.....	6, 10, 11, 55
As-Built.....	20, 23, 31, 48, 53
Bore.....	14, 20, 21, 22, 29, 36, 37, 38, 39, 40, 41, 54
Bridge.....	15, 18, 19, 21, 28, 29, 38, 43, 44, 48, 53, 54
CBUD	3, 16, 17, 21, 24, 47, 51, 53, 54
CC	3, 6, 14, 24, 26, 27, 29, 30, 33, 34, 35, 36, 38, 39, 40, 44
Construction Coordinator (CC).....	3, 54
Ditches	22, 27, 40, 42
Drone.....	16
EIC	8, 54, 58
Excavation.....	31, 54
Fall Arrest	43, 55
Fire Prevention.....	55
Flagger	14, 55
Flagging	7, 42, 50
FRA.....	7, 43, 54, 56, 58
Hot Work	33, 34, 55
Injuries	6, 10, 11, 55
On Track Safety	6, 7, 15, 55, 56
OSHA.....	29, 36, 39, 43, 44, 53, 58
RCL.....	10, 56, 58
Regen	56
REGEN	59
Right-of-Way	42, 56
Shoring.....	17, 36, 57
Signal	31, 57
Track Structure.....	57
Trench	18, 37, 57
Wet Bores.....	41, 57

ILLUSTRATION OF METHODOLOGY

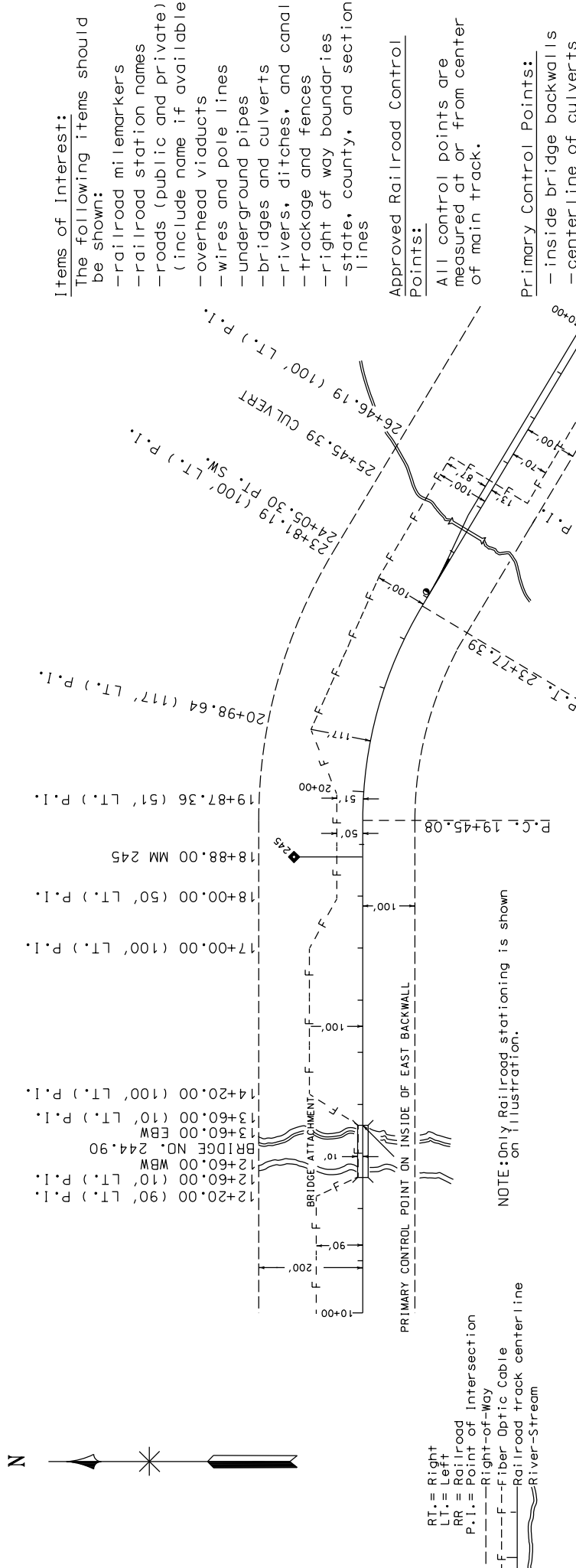

Key Points:

- Each running line change or point of intersection, facility, or point of interest must be located and labeled with the appropriate RR engineering stationing.
- All measurements of running line changes and fiber facilities must be shown from and at right angles to the centerline of main track. The distance to the next running line change or facility must be shown as measured along the centerline of main track and that distance shown on the map. If distances are measured from a side track, track centers to main track must also be measured.
- RR stationing must be shown for each point of intersection or running line change, and for each fiber optic facility. These items must be measured from the closest approved RR control point.
- The RR engineering stationing is obtained by using copies of existing RR right-of-way maps or the data generated by Precision Measurement Vehicle, which will establish the stationing of RR approved control points and all measurements must be referenced to these control points.
- Primary control points should be used whenever possible.

Submittal Notes:

- The "as built" (plans) provided to the railroad may be in either straight-line or geometric form on reproducible media (paper, vellum, mylar etc.). The data can be supplemented by a DXF or Intergraph CAD file.
- If Fiber Company is using other than RR stationing, then an identity equating the RR stationing to the fiber stationing must be used. However, RR stationing must be shown as stated above.
- Items of interest, such as milemarkers, should be shown on the "as built" for information only, and not used as control points to establish stationing.
- Items of interest such as rivers and roads should be shown on the "as built" with the applicable name or route number.

CAUTION:

Only control points that are verifiable on current Railroad maps are to be used.

Items of Interest:

- The following items should be shown:
- railroad milemarkers
 - railroad station names
 - roads (public and private) (include name if available)
 - overhead viaducts
 - wires and pole lines
 - underground pipes
 - bridges and culverts
 - rivers, ditches, and canals
 - trackage and fences
 - right of way boundaries
 - state, county, and section lines

Approved Railroad Control Points:

All control points are measured at or from center of main track.

Primary Control Points:

- inside bridge backwalls
- centerline of culverts
- point of switch on mainline turnouts

Secondary Control Points:

- overhead viaducts
- underpasses
- signals
- buildings (within the R-0-W)



Union Pacific RR

EXHIBIT B

METHODLOGY

FOR EQUATING FIBER OPTIC CABLE LOCATIONS TO RAILROAD TRACK & RIGHT-OF-WAY MAPS

NO SCALE

PCP: 01-01-22

EXHIBIT B-1

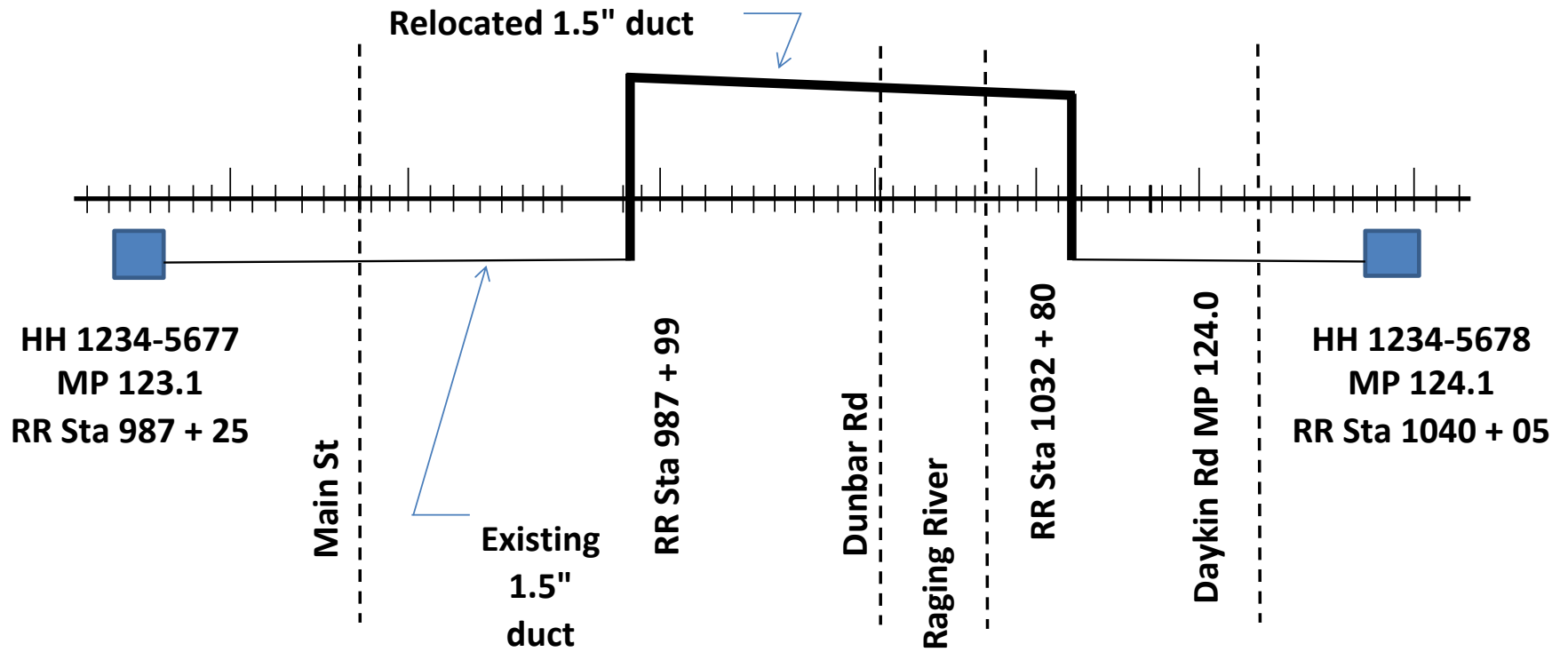

Straight Line Drawing

TYPICAL CONCRETE BRIDGE

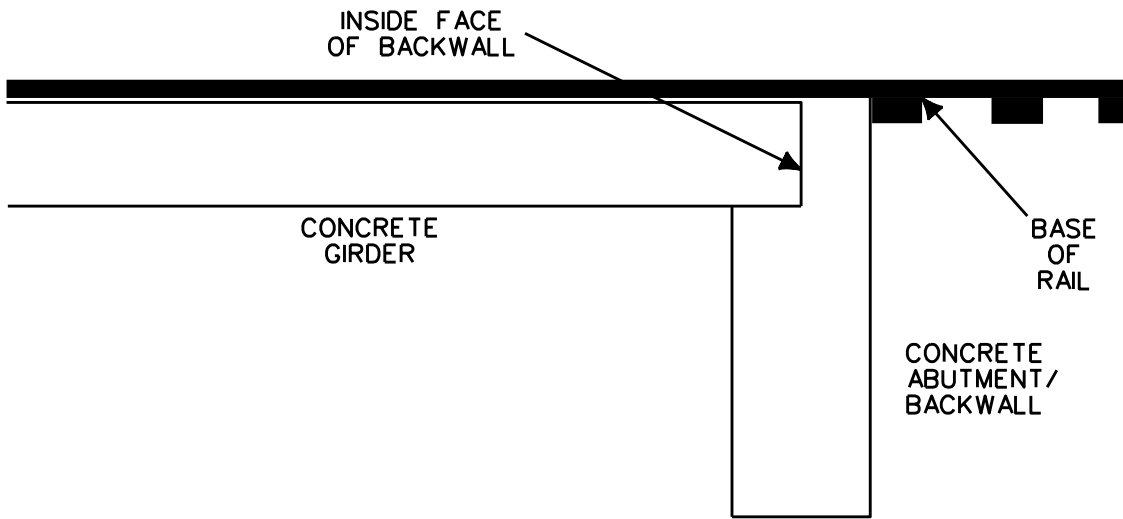

TYPICAL STEEL BRIDGE

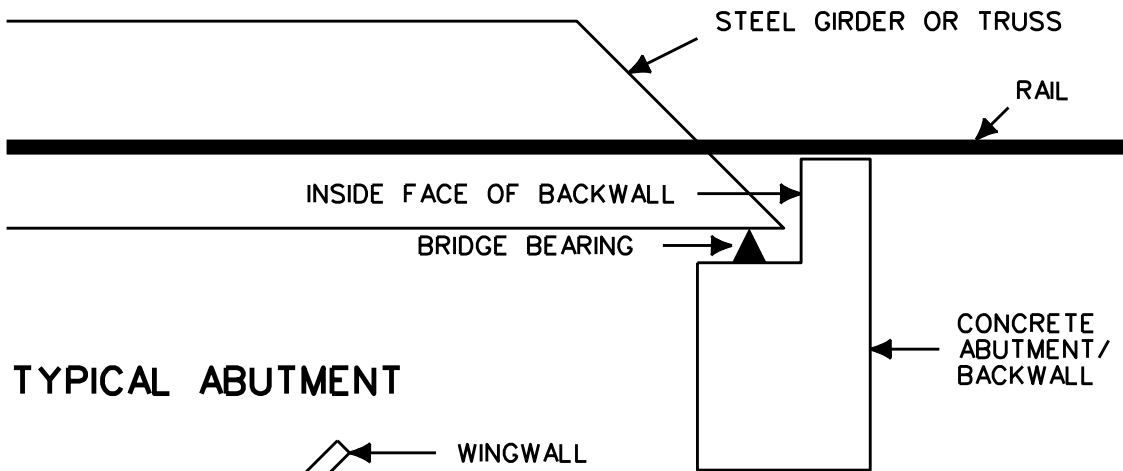

TYPICAL ABUTMENT

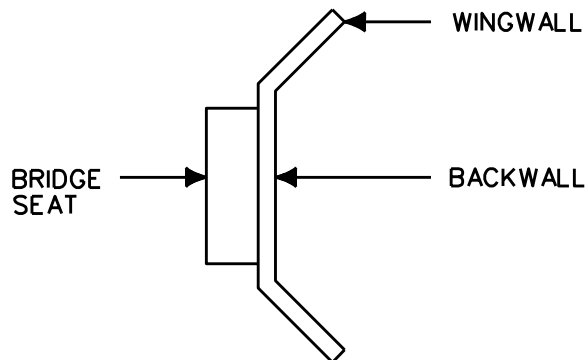

	Union Pacific RR
EXHIBIT C	
BRIDGE DEFINITION	
NO SCALE	PCP: 01-01-22

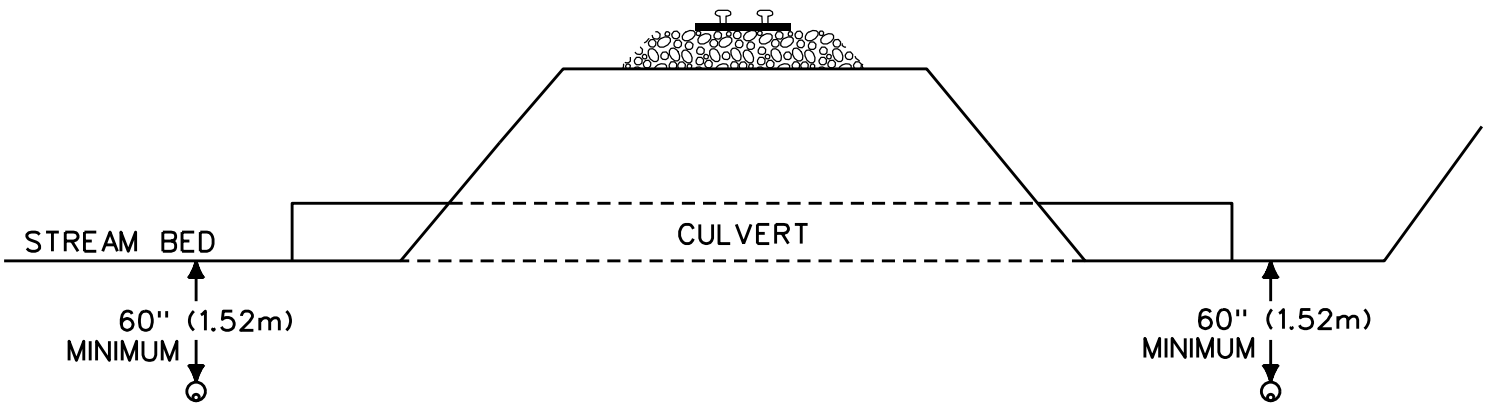
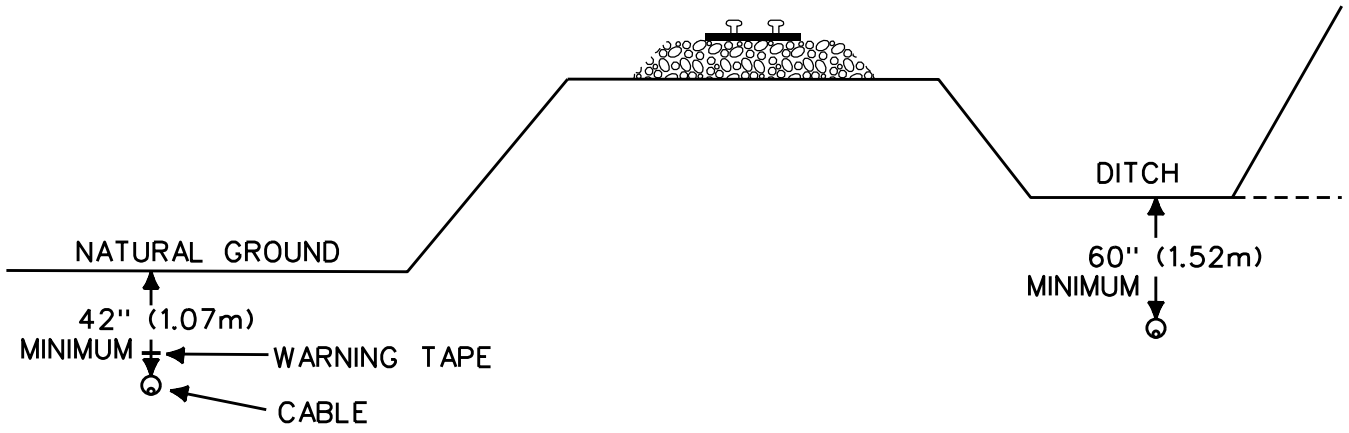

	Union Pacific RR
	EXHIBIT D CABLE DEPTH AROUND CULVERTS AND DITCHES
<small>NO SCALE</small>	<small>PCP: 01-01-22</small>

EFFECTIVE DATE: JANUARY 1, 2022

ALL UNDER TRACK BORES ARE TO BE AT 90 DEGREES WHEN USING A DIRECTIONAL BORE, AN ANGLE OF 60 DEGREES OR GREATER CAN BE USED AT THE DISCRETION OF THE CC.

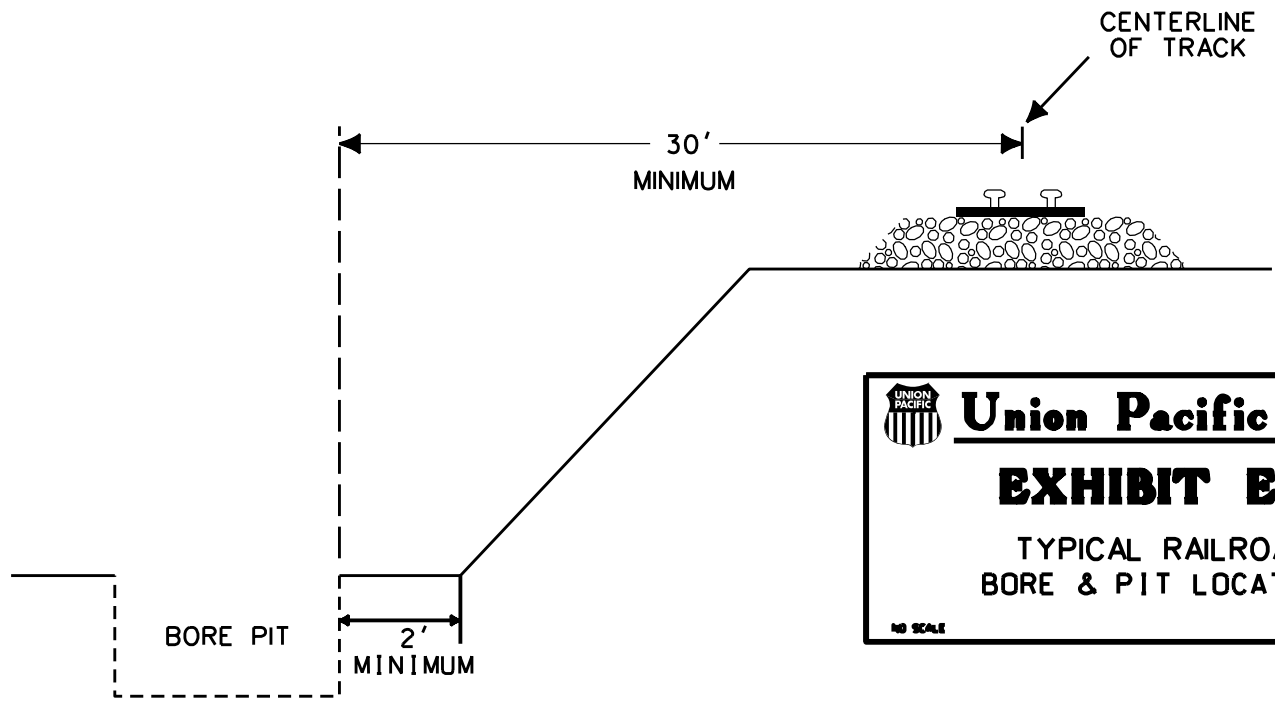
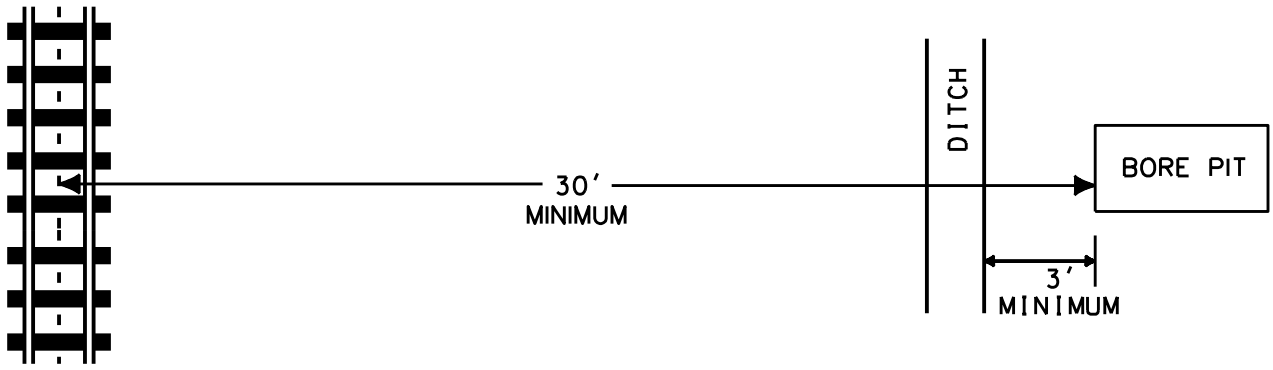
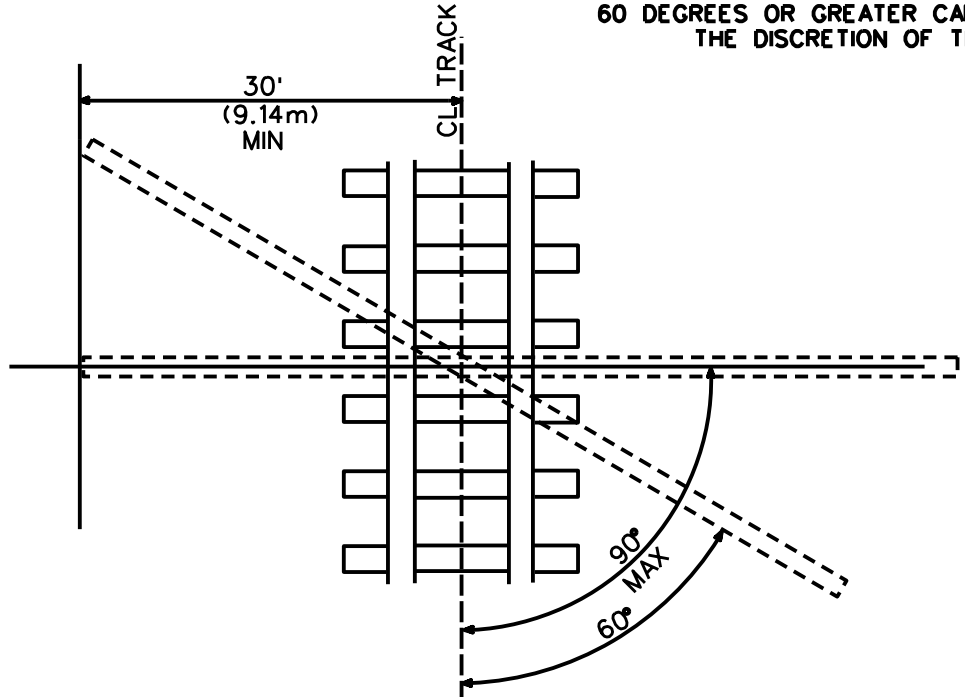



Union Pacific RR

EXHIBIT E

TYPICAL RAILROAD
BORE & PIT LOCATION

NO SCALE PCP: 01-01-22

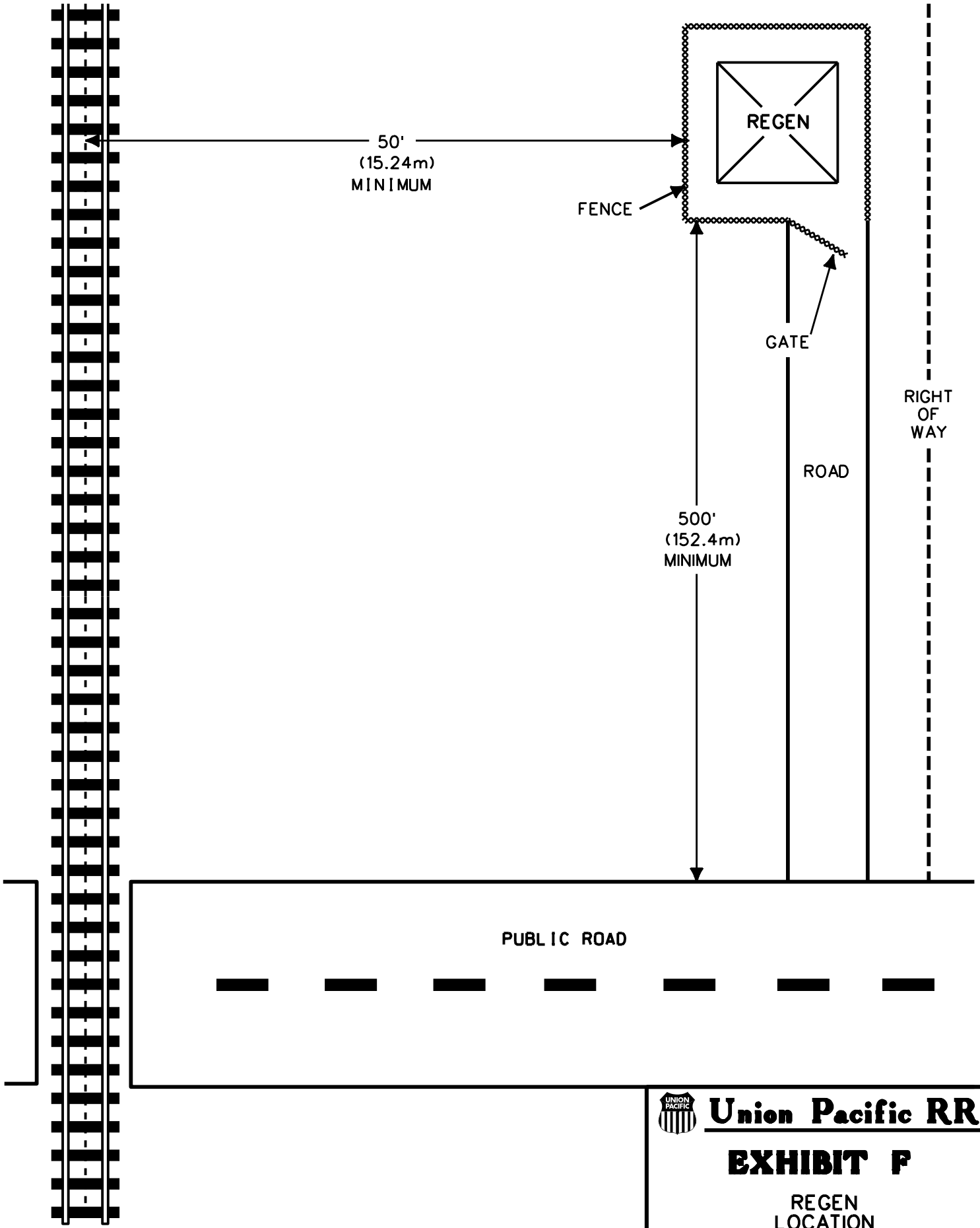

 **Union Pacific RR**

EXHIBIT F

REGEN
LOCATION

NO SCALE PCP 01-01-22

EFFECTIVE DATE: JANUARY 1, 2022

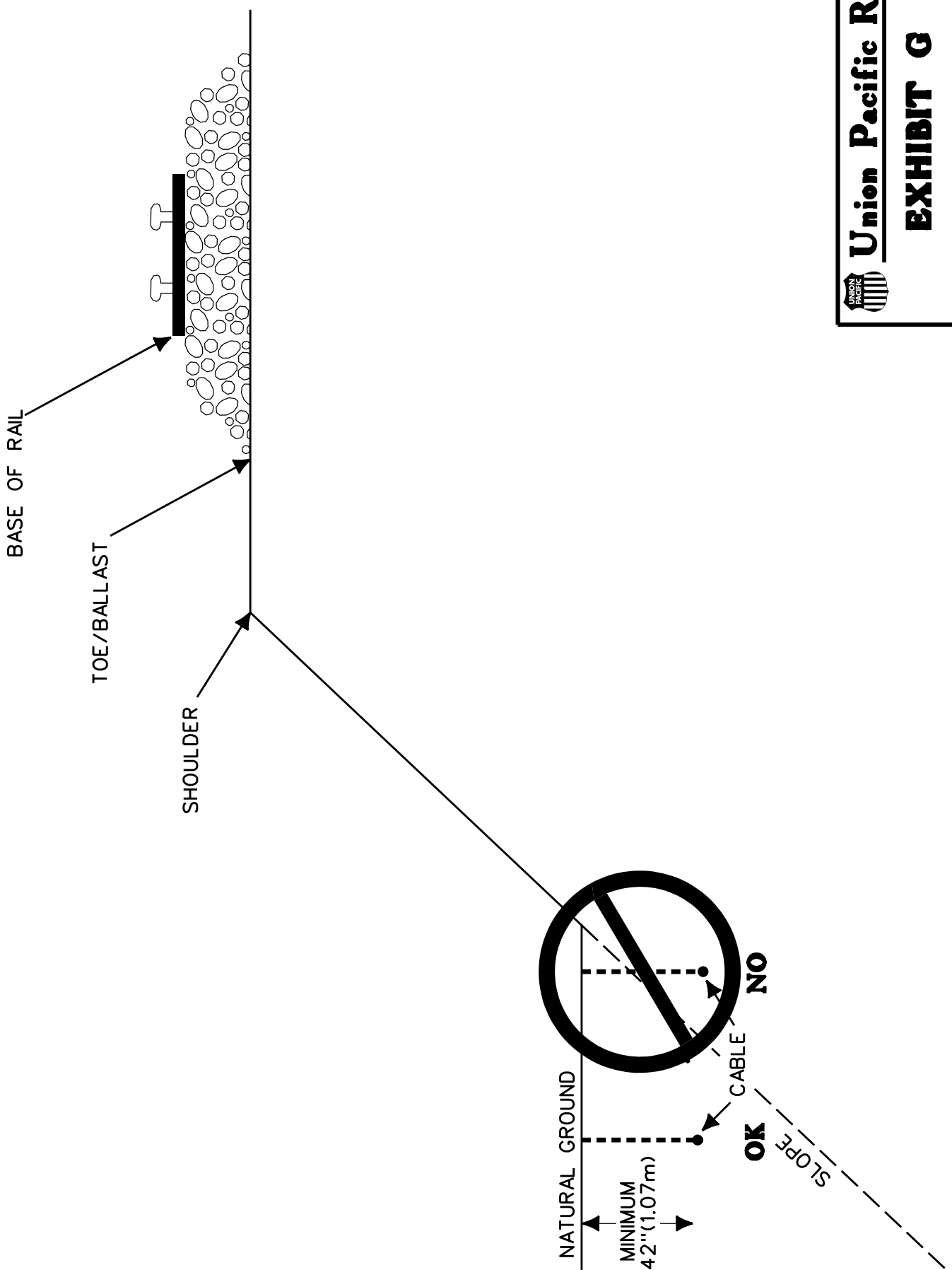

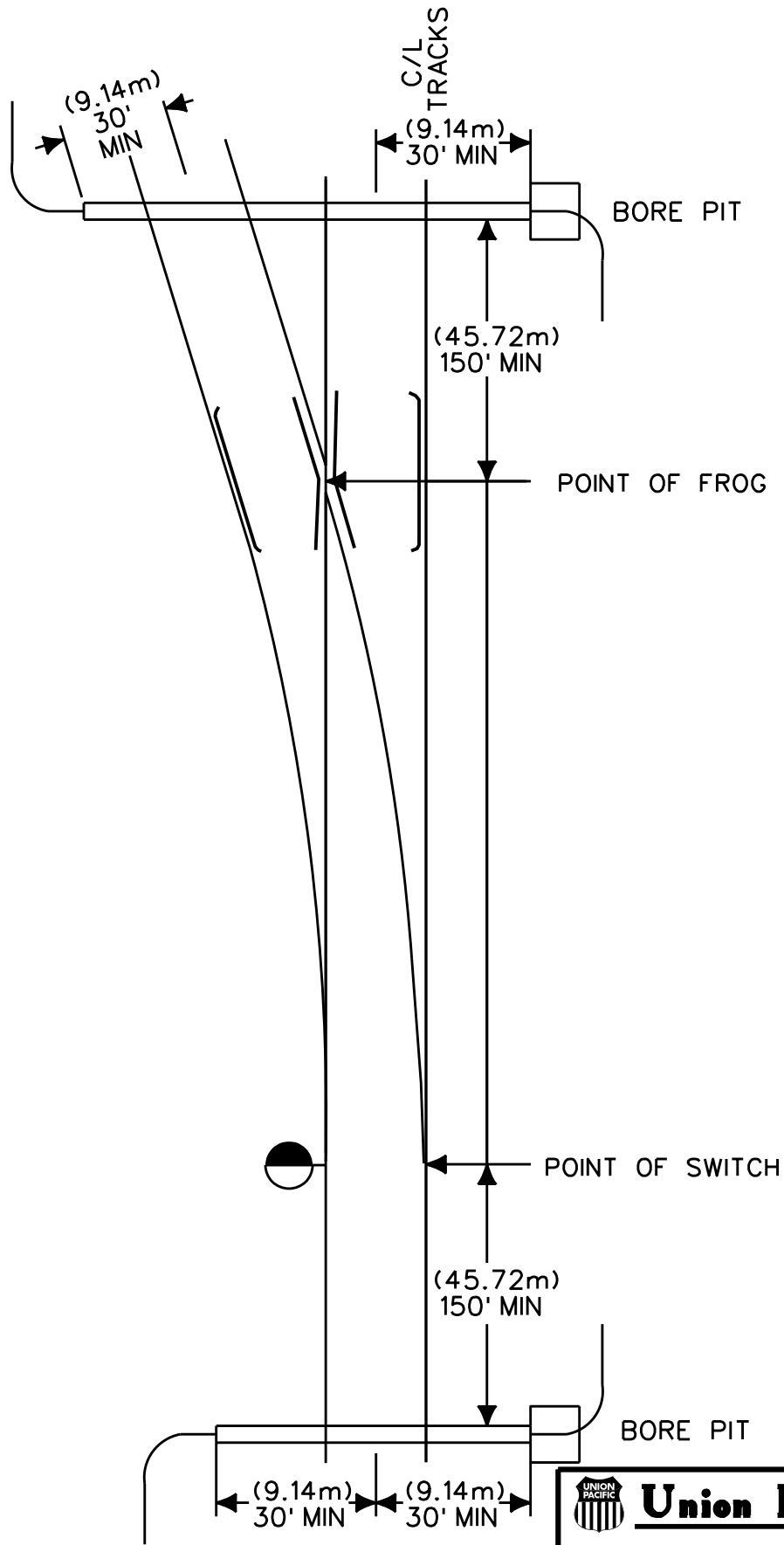

	Union Pacific RR
	EXHIBIT H
	STANDARD TURNOUT
<small>NO SCALE</small>	<small>PCP: 01-01-22</small>

EFFECTIVE DATE: JANUARY 1, 2022

UPRR & BNSF GUIDELINES FOR TEMPORARY SHORING, 12/7/2021

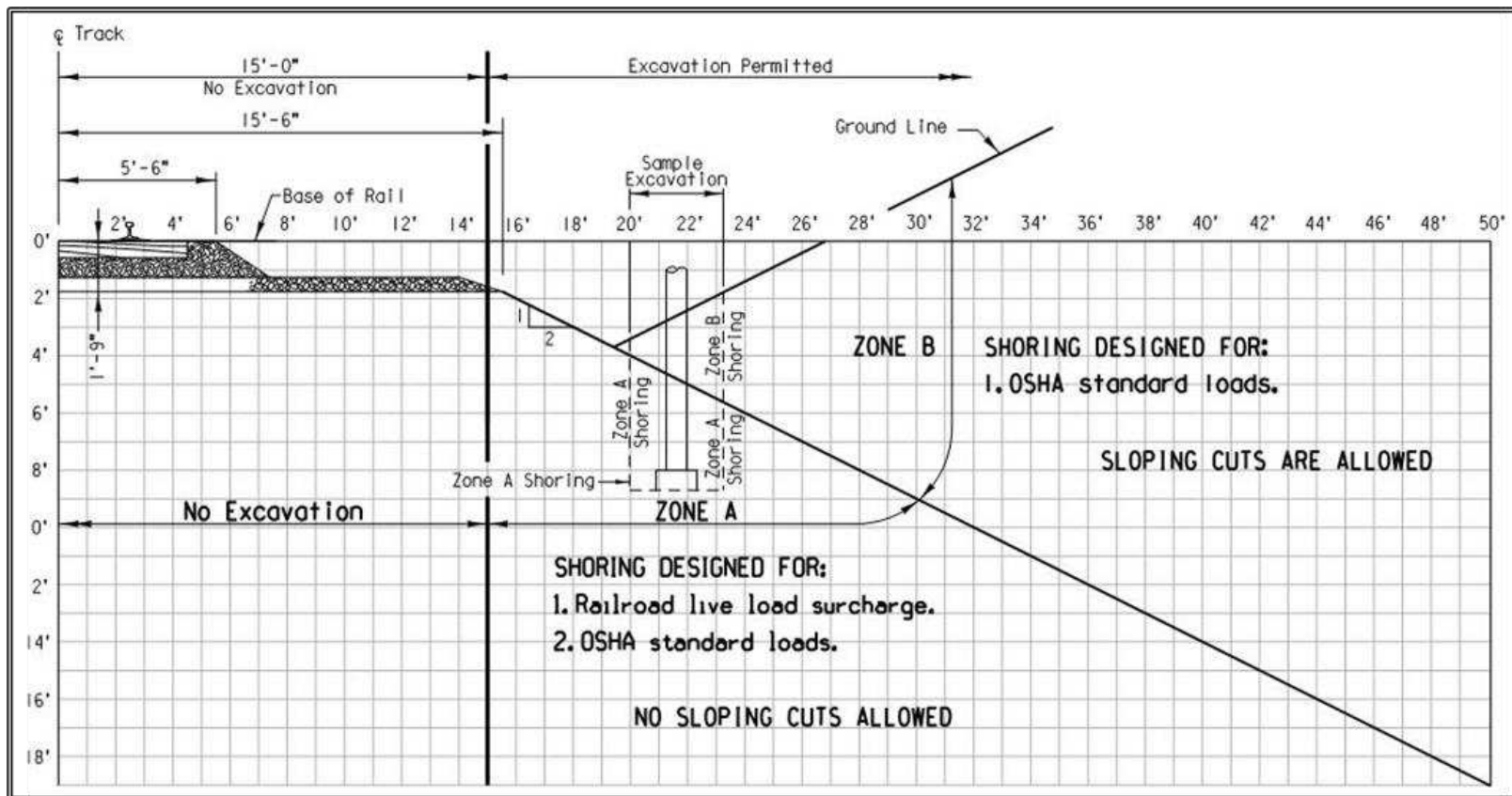

Shoring Zones :

- i. All dimensions are measured perpendicular to the centerline of track.
- ii. For ALL excavations within Zone A, shoring plans shall be accompanied by design calculations.
- iii. All shoring within the limits of Zone A must be placed prior to the start of excavation.



Union Pacific RR

EXHIBIT J

FILL INSTALLATION
DIRECTIONAL BORE

UP 8241

PCP 01-01-22

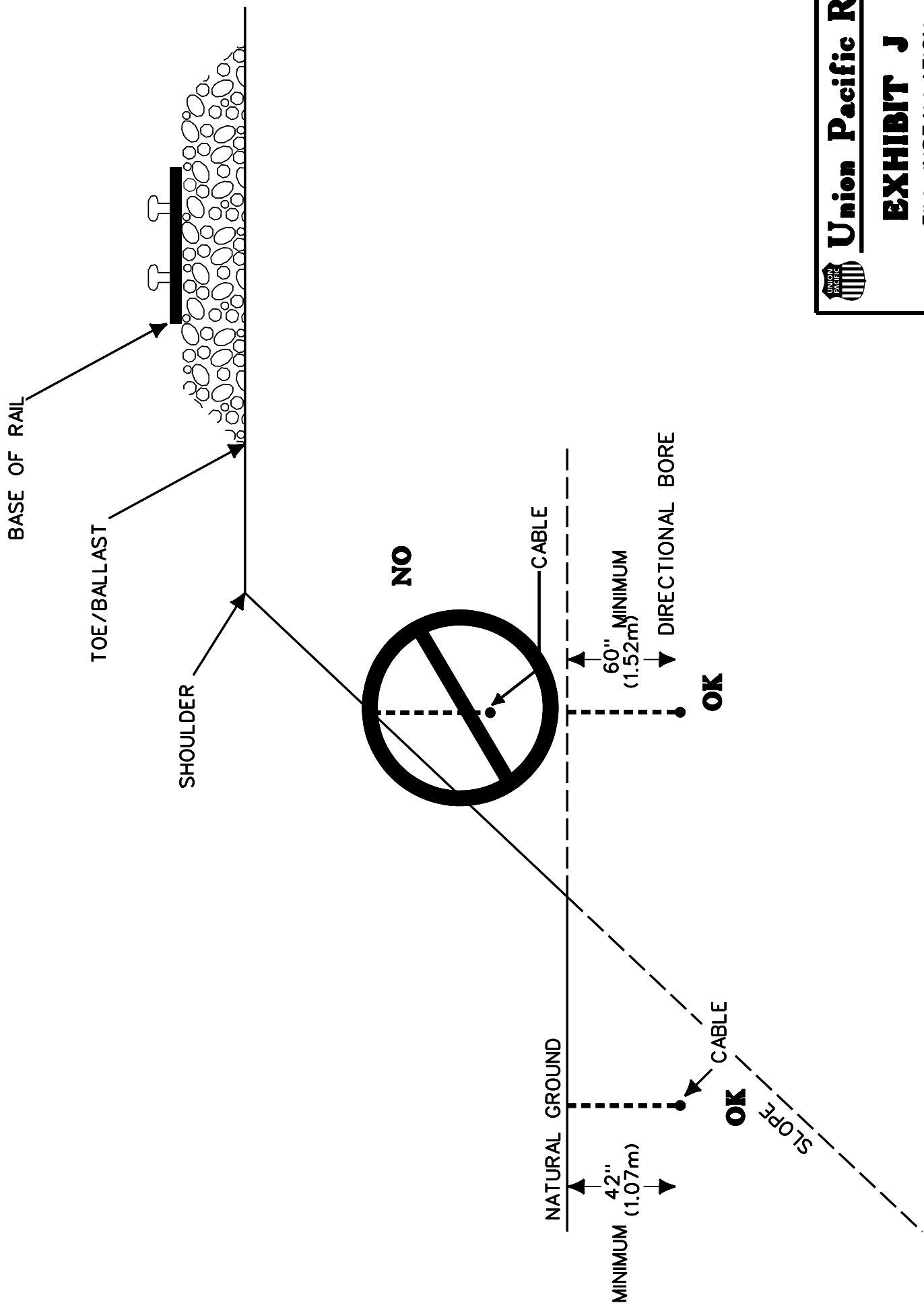

EFFECTIVE DATE: JANUARY 1, 2022

EQUIPMENT
NOT ALLOWED
WITHIN 5'
UNDISTURBED
AREA

5' (1.52m) MIN

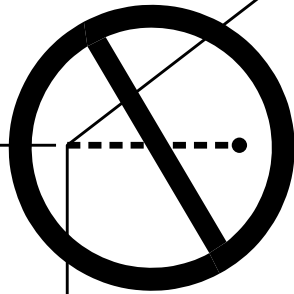

NO

42" (1.07m)

MINIMUM

OK

BASE OF RAIL

TOE/BALLAST

GROUND LINE

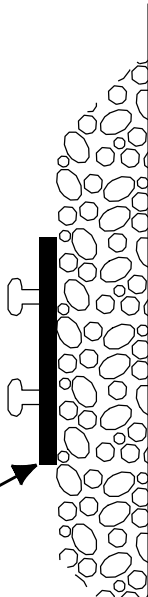

Union Pacific RR

EXHIBIT K
INSTALLATION
ON
TOP OF CUT

NO SCALE

PC: 01-01-22

EFFECTIVE DATE: JANUARY 1, 2022

WIRE LINES WITH LESS THAN 750 VOLTS IN NON-ELECTRIFIED TERRITORY
 27'-0" ABOVE TOP OF RAIL MINIMUM
 (IN ELECTRIFIED TERRITORY--35'-0" ABOVE TOP OF RAIL MINIMUM)

(SEE M/W RULE 54.1 FOR HIGHER VOLTAGES)

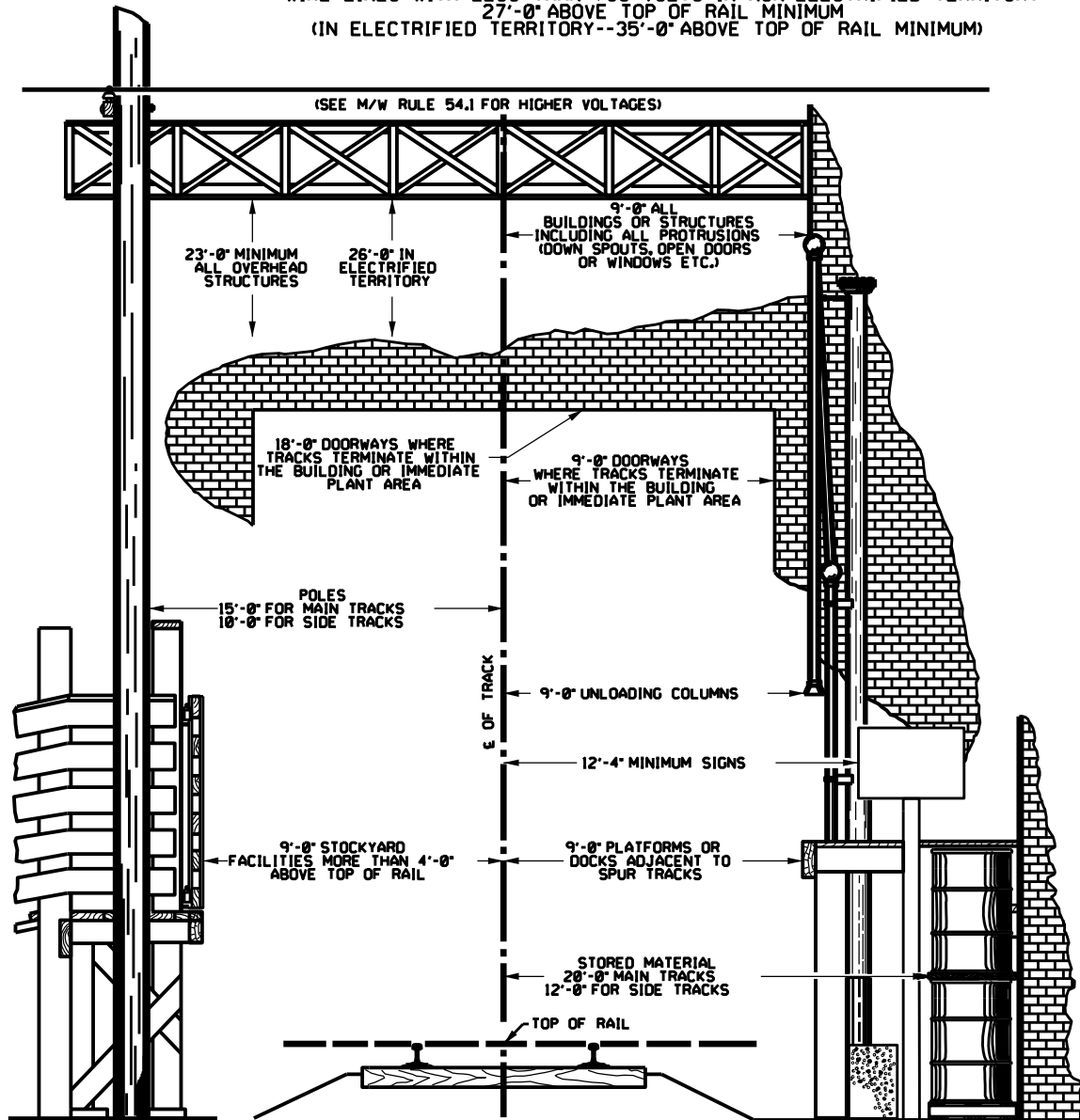

STRUCTURES AND INDUSTRY FACILITIES

TRACK NOTES

TRACK CENTERS:

TWO OR MORE MAIN TRACKS WILL BE A MINIMUM OF 15'-0" CENTER TO CENTER
 SIDE TRACKS ADJACENT TO A MAIN TRACK WILL BE A MINIMUM OF 15'-0" CENTER TO CENTER.

ANY TWO OR MORE SIDE OR INDUSTRY TRACKS WILL BE A MINIMUM OF 14'-0" CENTER TO CENTER.

LADDER TRACKS AND ANY ADJACENT TRACK WILL BE A MINIMUM OF 20'-0" CENTER TO CENTER.

TEAM TRACKS IN PAIRS MAY BE A MINIMUM OF 15'-0" CENTER TO CENTER.

ELECTRIFIED TERRITORY REFERS TO TRACKS WHERE ELECTRIC LOCOMOTIVES OPERATE.

SUPERELEVATION:

AN ADDITIONAL 4.25" HORIZONTAL CLEARANCE AT 20'-0" ABOVE TOP OF RAIL MUST BE ALLOWED ON THE LOW RAIL SIDE FOR EACH ONE INCH OF SUPERELEVATION TAPERING TO ZERO INCHES ADDITIONAL CLEARANCE AT THE TOP OF THE RAIL

GENERAL NOTES

ALL STRUCTURES OF FACILITIES NOT SHOWN MUST BE AT LEAST 90' FROM THE CENTER LINE OF TRACK AND AT LEAST

EFFECTIVE DATE: JANUARY 1, 2022



Union Pacific RR

EXHIBIT L

STANDARD FOR
MINIMUM CLEARANCES

NO SCALE PCP: 01-01-22

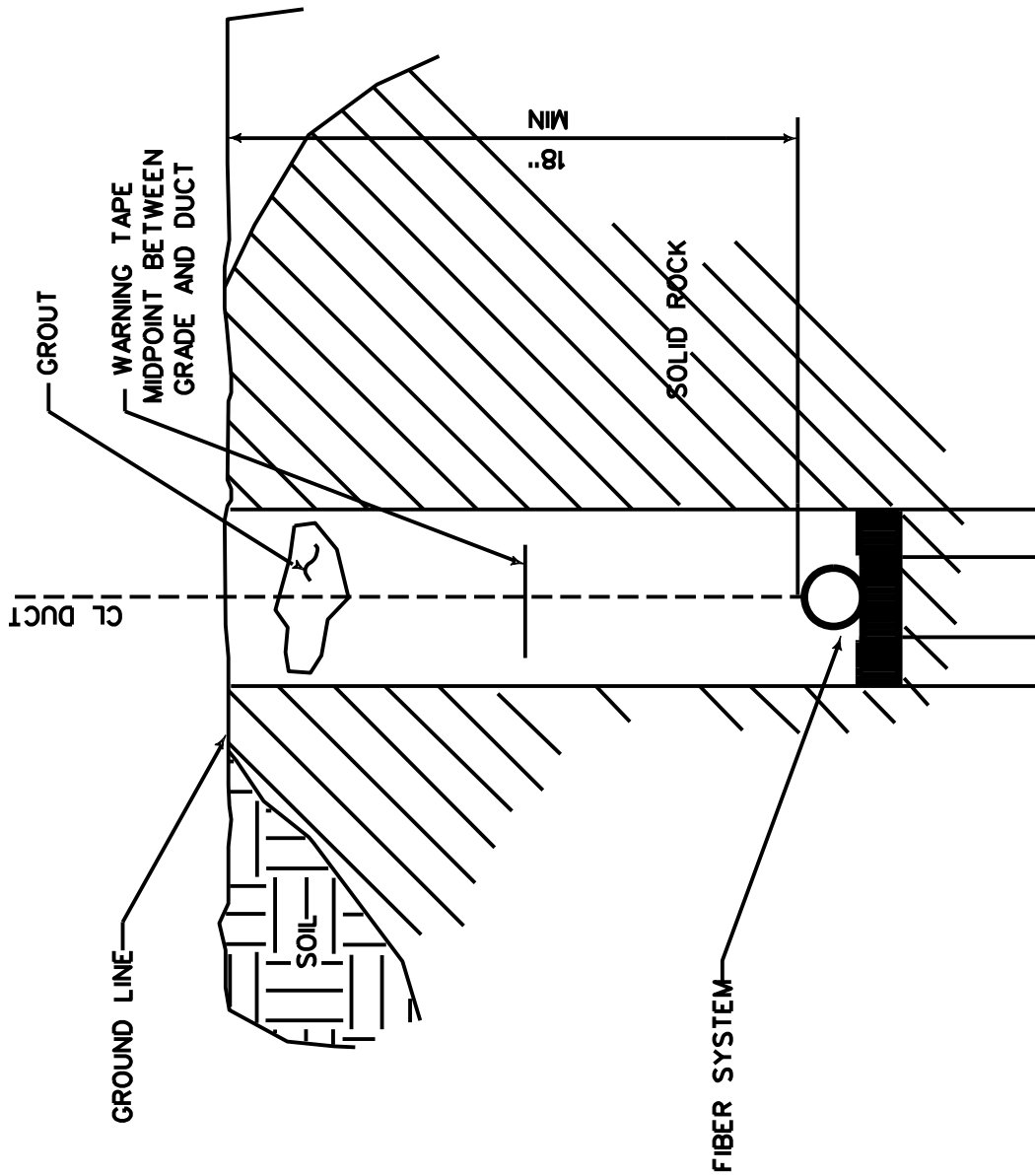

NOTES

UNTIL OR UNLESS THE CABLE SYSTEM IS AT THE DESIRED 42" DEPTH, THE ROCK TRENCH SHALL BE CUT AT A DEPTH OF 18", REGARDLESS OF GROUND LINES.



Union Pacific RR

EXHIBIT N

ROCK TRENCH

NO SCALE

PC: 01-01-22

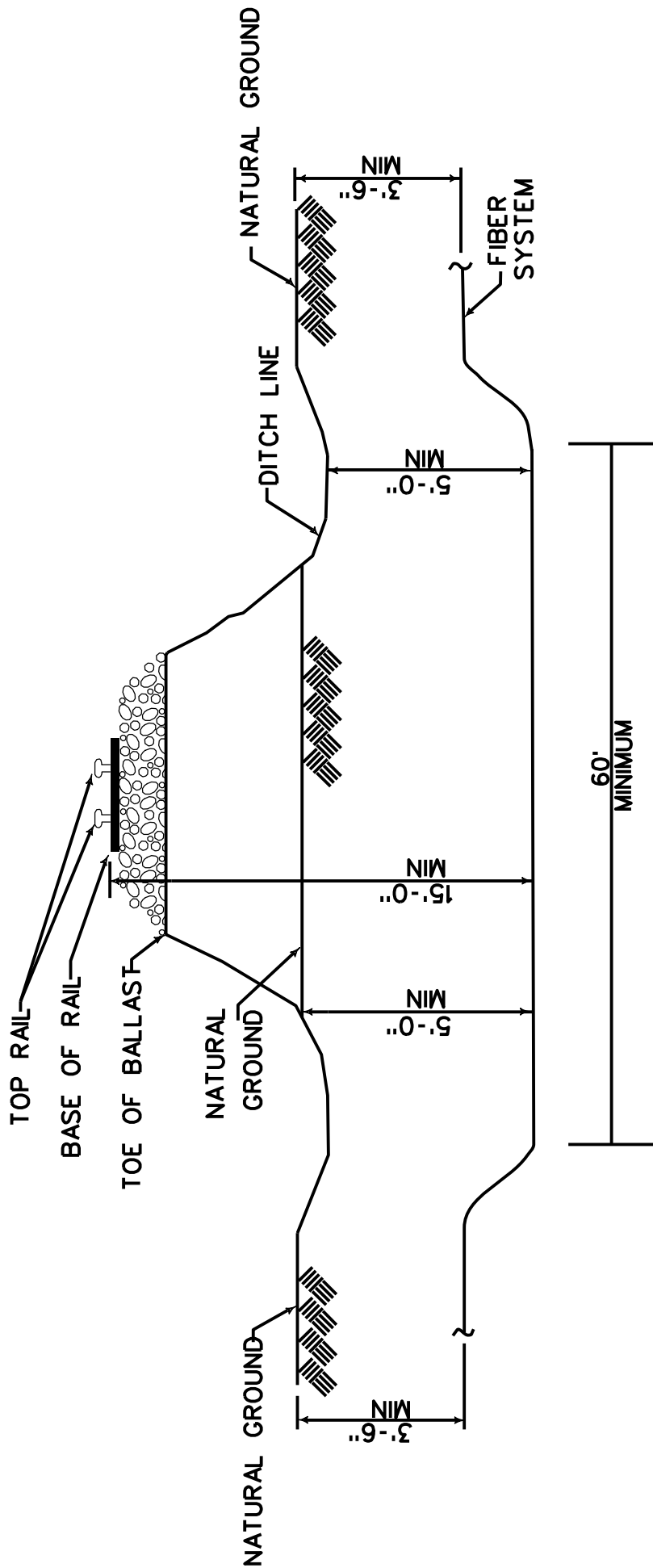

EFFECTIVE: JANUARY 1, 2022



EXHIBIT O
 TYPICAL RAILROAD
 DIRECTIONAL BORE DEPTH

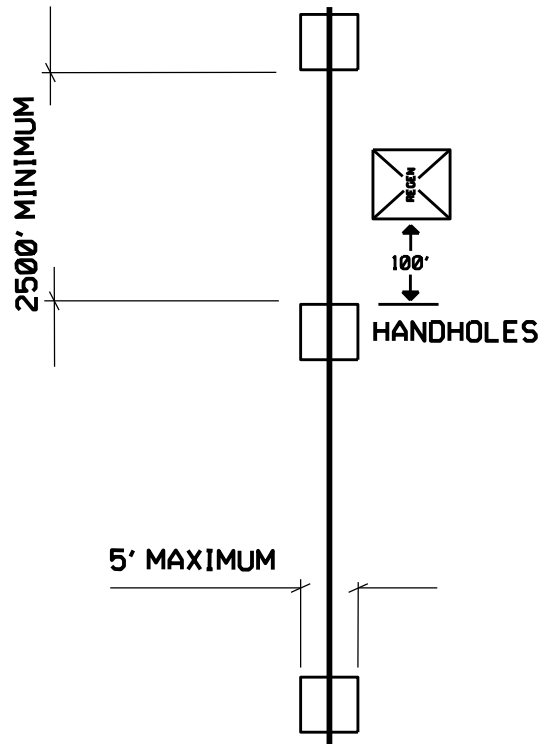

RIGHT OF WAY

HANDHOLES MUST HANDLE H-20 LOADING



DO NOT CLUSTER!!
HANDHOLES MUST RESIDE IN THE RUNNING LINE

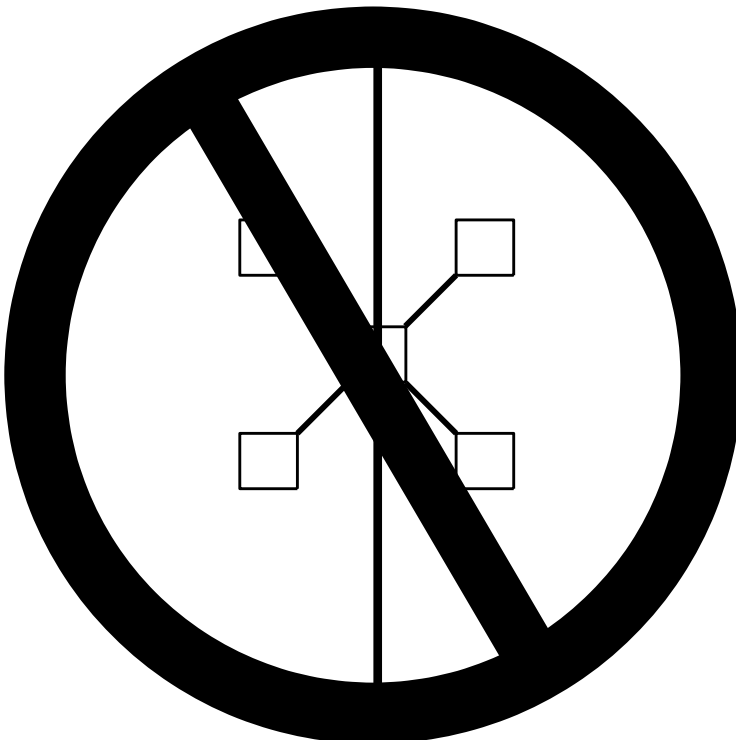

RIGHT OF WAY

	Union Pacific RR
EXHIBIT P	
HANDHOLE LOCATION	
<small>NO SCALE</small>	<small>PCP: 01-01-22</small>

EXHIBIT Q

HOT WORK CHECKLIST

Date of Issue / Use: _____

Issued By: _____ Signature: _____

(Print Name Legibly)

Contractor Name: _____

Location or Work: _____

Task To Be Performed: _____

Specific Fire Hazards: _____

(Dried Grasses, Flammable Liquids, Combustible Materials i.e. wood, cardboard, etc.)

Hot Work Is: Any activity that creates live flame, molten slag, or sparks and includes: Metal cutting, welding, grinding, cut-off saw on metal or dry concrete, etc. Open warming fires are not allowed in any manner, shape or form.

NOTE: The location in which this Hot Work is to be performed shall be inspected before the Hot Work operations begin. The Hot Work shall not commence until all of the precautions noted below are in place.

FIRE SAFETY PRECAUTIONS

BEFORE THE WORK – All of the following precautions must be taken. Please initial the boxes at the left as completed.

- [] Cutting and/or welding equipment must be thoroughly inspected and found to be in good repair, free of damage or defect.
- [] Two fully charged, 20-lb minimum, multi-purpose dry chemical (ABC) portable fire extinguishers must be located at the point of operation.
- [] A means of contacting the Emergency Fire Services as noted with the Emergency Response Form must be available and accessible to the person(s) conducting the Hot Work operation.
- [] All equipment fueling activities and fuel storage, including portable fuel cans, must be located a minimum of 100 feet from the Hot Work location.
- [] 50 Gallons of water must be on hand, immediately available and reserved for firefighting purposes, along with one round nose shovel at least 46 inches in length for every employee involved in the Hot Work..
- [] Pre-Inspect the Hot Work area to remove, cover, or wet down any available combustible materials, i.e. dry grasses or brush, wood, RR ties, scrap, rubbish, etc. **(Step 1)**
- [] Spark shields must be used for the Hot Work.

DURING / AFTER THE WORK – The following precautions will be taken:

- [] A properly trained Fire Watch person must be assigned to watch for unwanted fires for a minimum of 30 minutes following all Hot Work activities. **There are no exceptions. (Step 2)**
- [] Fire watch persons must have immediate access to fully charged, 20-lb minimum, multi-purpose dry chemical (ABC) portable fire extinguisher, water based extinguisher, shovels and communication device all as noted above.

- The location where the Hot Work will take place has been **inspected before the start of the Hot Work operations** and all of the precautions listed above have been taken. **Responsible party must sign under Signature 1.**
- The work area and all adjacent areas have **been inspected 30 minutes after the Hot Work operation** has ceased for the day / period and found to be fire safe. **Responsible party to sign under Signature 2.**

Date: _____ Before: _____ After: _____

Signature 1 & Time

Pre-Work Inspection (Step 1)

Signature 2 & Time

Post-Work Inspection (Step 2)

Effective January 1, 2022

EXHIBIT R

The guidelines in this checklist are key factors often present at work sites; however, it is not an all-inclusive listing. Each excavation must fully comply with the most restrictive of applicable OSHA, State and/or Railroad requirements.

Trench Safety Inspection Checklist

Location: _____ **Date:** _____

Weather Conditions: _____

“Competent Person”: _____

Dimensions: Depth _____ **Width** _____ **Length** _____

Soil Type: Rock _____ **Average Soil** _____ **Clay** _____ **Sand** _____

Hazardous Conditions: Vibration _____ **Wet Soil** _____ **Placement of Spoils** _____

Additional Loads on Trench: Vehicles _____ **Buildings** _____ **Other** _____

Protection: Shoring _____ **Ladder** _____ **Sloping** _____ **Benching** _____

Fall Safety: Yes ____ **No** ____ (If six feet (6') or deeper, must have sides protected)

Confined Space Permit Required? Yes _____ **No** _____

Distance from Track: _____

Is Trench Safe to Enter? Yes _____ **No** _____

Notes: _____

EXHIBIT S

Drawing Submittal Minimum Requirements:

Check off each item or provide short explanation why it is not included. If you are unsure, contact one of the engineers listed in Exhibit A before submitting drawings with missing information. INCLUDE THIS DOCUMENT WITH YOUR PLAN SUBMITAL.

A. New Route Construction (for modifications or additions to existing systems see Section B, below)

- Railroad methodology for equating fiber optic cable locations to railroad track and right-of-way maps. (refer to Exhibit B)
- Title page indicating FIBOCO name, Railroad subdivision name and Mile Post, city (or city pair) and state(s).
- Location map (can be included on title page).
- Drawing format: 11"x17", professionally prepared with computer-aided drafting (CAD). Submitted electronically in pdf format.
- Standard detail sheets for hand holes/manholes, construction methods, marker signs, and other typical features.
- Design drawings for all encroachments on Railroad right-of-way. (Details for work off Railroad right-of-way may be included for illustration or clarity but will not be included in the approved plan set.)
- Include on the drawing set the FIBOCO project number for reference.
- Submit route construction plans at a scale of 1"=100' (2.54cm=30.48 meters).
- Include sections and exhibits at a larger scale where complex detail is required.
- All necessary dimensions measured at right angles to the centerline of the nearest mainline track (and other tracks if closer).
- The Railroad's right-of-way limits, mainline track, sidings, spur tracks, Railroad mile markers, and Railroad station names, on both sides of the track, not just the side of the proposed fiber optic running line. Include Railroad stationing and, if used, corresponding FIBOCO stationing for each landmark. Station names are found on Railroad Val Maps for the route.
- Overpasses with road name and the Railroad's mile marker designations. Show bridge piers in relation to the Railroad's track, the fiber system and any culverts.
- All utility crossings (both underground and overhead), parallel underground utilities, pole lines, signals, signal houses, and other signal facilities.
- Public and private street and road crossings with street names. Show Railroad stationing and corresponding FIBOCO stationing at road centerline.
- Rivers, fences, landmarks, and any other facilities, which will aid in identifying the fiber system location.
- The Railroad "Call Before You Dig" number, 1-800-336-9193, and instructions for its use.
- Fiber system running line changes and bore locations indicating Railroad stationing and, if used, corresponding FIBOCO stationing.
- Conduit size and count, and fiber cable count.
- North arrows, scales and directional orientations on all sheets. Directional orientations include Railroad station names and/or mile post numbers in each direction at the edge of each sheet.
- County names.
- Railroad bridges and culverts with proper bridge/culvert number. (The bridge/culvert number is usually, but not always, related to the mile post location and can be found on the Railroad Val Map for the route, as well as on the structure.)
- Refer to Section 3.15 - Trenchless Installations of Fiber Systems, for plan submittal requirements. ALL directional bores under any track must be shown in engineered site detail, not just generic exhibits. Include all boring and casing details on the design drawings. This includes, but is not limited to, dimensions, bore pit locations, and casing specifications. Include a bore profile for all under-track bores

Exhibit S continued

- ❑ Hand holes: Refer to Section 3.7.15, 3.7.16 and 3.7.17 for hand hole plan submittal information.
- ❑ Include "original" and "revised" dates on all revised drawings.
- ❑ Show the location of fiber system marker signs on the design drawings, and submit a detail of the sign, including color of the sign, for Railroad approval. This also applies to aerial marker signs.
- ❑ Furnish drawings of each regen site along with the running line drawing. This drawing should show the same information mentioned in the previous sections. Other details to be included are: the distance from the regen building to the centerline of all tracks, grade crossings, planned access and other facilities to the site. Also include plans for power supply required for the regen building including voltage, above ground clearances, below ground dimensions and building access. Drawings should also include all planned utility installations (such as gas, water, additional telecommunications) to regen site.
- ❑ Show on the design drawing(s) the reasons for deviations in the running line of the fiber optic cable system, such as steep banks, water crossings, ditches, obstacles, etc.

B. DRAWINGS - MODIFICATIONS TO EXISTING FACILITIES

- ❑ Cover sheet to include:
 - Project name.
 - Project Number.
 - Location Plan.
 - Any map or plan that includes enough information to locate project separately.
 - Include nearby streets, highways, towns, etc.
- ❑ Include Site Plans for laterals, bores, relocations and anything requiring more detail.
- ❑ The Site plan shall include more detailed information than the Location Plan:
 - All relevant dimensions
 - Railroad Stationing.
 - References to existing hand hole/manhole designations. This will match the designation on the As-Built Plans.
 - Include number of ducts.
 - Duct size(s).
 - Fiber Strand Count.
 - Distance along track.
 - Distance to edge of right-of-way and CL/Trk
- ❑ Submit appropriate reference sheets.
- ❑ Include existing UPRR Approved As-Built Plan(s).
- ❑ If existing duct is used on multiple sheets, include only first and last sheets, plus the sheet that indicates the nearest Mile Post, and any sheets where facilities are added or moved.
- ❑ For projects that include over pulling fiber cable in existing ducts for several miles, include a Straight Line type drawing that generally includes (Refer to Exhibit B-1):
 - Beginning and ending Mile Posts.
 - Beginning and ending Railroad Stationing.
 - Major street crossings along the route.
 - If the duct package is being modified in the middle of the project, identify which is new duct, and which is existing duct.

EXHIBIT T

RAILROAD EMERGENCY RESPONSE FORM

LOCATION (RAILROAD SUBDIVISION AND MILEPOST) _____

CLOSEST CITY AND DIRECTIONS FROM THE JOB SITE (OR NEAREST CROSSING IF JOB SITE IS INACCESSIBLE FROM ROADWAY):

CLOSEST HOSPITAL AND DIRECTIONS FROM THE JOB SITE (OR NEAREST CROSSING IF JOB SITE IS INACCESSIBLE FROM ROADWAY):

NEAREST EMERGENCY SERVICES:

AMBULANCE: (_____) _____

FIRE: (_____) _____

POLICE (_____) _____

RAILROAD CONTACTS: _____

NAME: _____

PHONE: _____

CELLULAR: _____

EMERGENCY NUMBERS:

GRADE CROSSING HOT LINE 1-800-848-8715

UPRR CBUD 1-800-336-9193

**SPECIAL AGENT OR RMCC 1-888-UPRR-COP (1-888-877-7267)
or 1-800-892-1283**

Union Pacific Railroad

Fiber Optic Construction and Maintenance

ZERO TOLERANCE SAFETY PRACTICES

- No excavation may take place without a valid Union Pacific dig ticket. For planned work create a ticket at www.up.com/cbud. For emergencies call 1-800-336-9193.
- All fiber optic workers must be safety trained and have a valid Union Pacific issued safety sticker on their hardhat.
- All personnel must wear a Union Pacific Railroad approved hard hat, safety glasses, highly visible orange outer wear that include reflective striping and safety-toe work boots.
- All running line changes must be approved by the Union Pacific Railroad Construction Coordinator. Flaggers are provided for protection from trains. Flaggers cannot approve running line changes or allow any deviation from the Union Pacific fiber optic safety policy.
- Before any train passes - stop all work, stand back well away from the track and watch the train pass.
- **WORKING ON OR AROUND TRACKS:**
 1. All work within or at 25' of centerline of track must be coordinated with the Construction Coordinator and shall utilize train protection. Such protection shall be provided by a watcher or flagger as governed by Rule 15.2.2-Protection for Non-Railroad Employees as covered by Railroad's System Special Instructions.
 2. All work outside 25' of centerline must be coordinated with the Construction Coordinator.
- Do not foul the track with any piece of equipment without a flagger and positive protection.
- Do not stand on the tracks or within 10' of the centerline of the track. The track is not an observation platform!
- Any excavation/hole less than 15' of centerline of track must be filled or properly shored prior to any train passing.
- No open excavation/holes left unattended.
- Do not disturb or foul the ballast at any time.
- Do not write on the rail or ties.
- All trenches must be shored conforming to the Joint UP/BNSF Guidelines for Temporary Shoring.
- All work is limited to 10 hours each day between sunup and sun down. It must be completely light during work hours.
- No work will be allowed on Railroad property on Sundays or Holidays.
- All Union Pacific Railroad fall protection instructions must be followed.
- All confined space and trench entry and/or occupation shall comply to OSHA Standard 29 C.F.R. 1910.146.
- **AT THE DISCRETION OF UNION PACIFIC RAILROAD, VIOLATION OF ANY OF THESE RULES WILL RESULT IN A MINIMUM OF THREE WORK DAYS OFF THE PROJECT, AND SUBJECT TO FURTHER DISCIPLINARY ACTIONS FROM FIBER OPTIC COMPANY.**